A white line-art illustration on a grey background. The top part shows a large, multi-story building with many windows and a central entrance. Below the building, there are several plants, including what looks like a corn cob and some leafy greens. The text 'MOL.911' and 'Transgenic Plants' is overlaid on this illustration.

MOL.911

Transgenic Plants

TABLE 18.1 Plant cell DNA-delivery methods

Method	Comment
Ti plasmid-mediated gene transfer	An excellent and highly effective system that is limited to a few kinds of plants
Microprojectile bombardment	Used with a wide range of plants and tissues; easy and inexpensive
Viral vectors	Not an effective way to deliver DNA to plant cells
Direct gene transfer into plant protoplasts	Can be used only with plant cell protoplasts that can be regenerated into viable plants
Microinjection	Has limited usefulness because only one cell can be injected at a time; requires the services of a highly skilled individual
Electroporation	Generally limited to plant cell protoplasts that can be regenerated into viable plants
Liposome fusion	Can be used only with plant cell protoplasts that can be regenerated into viable plants

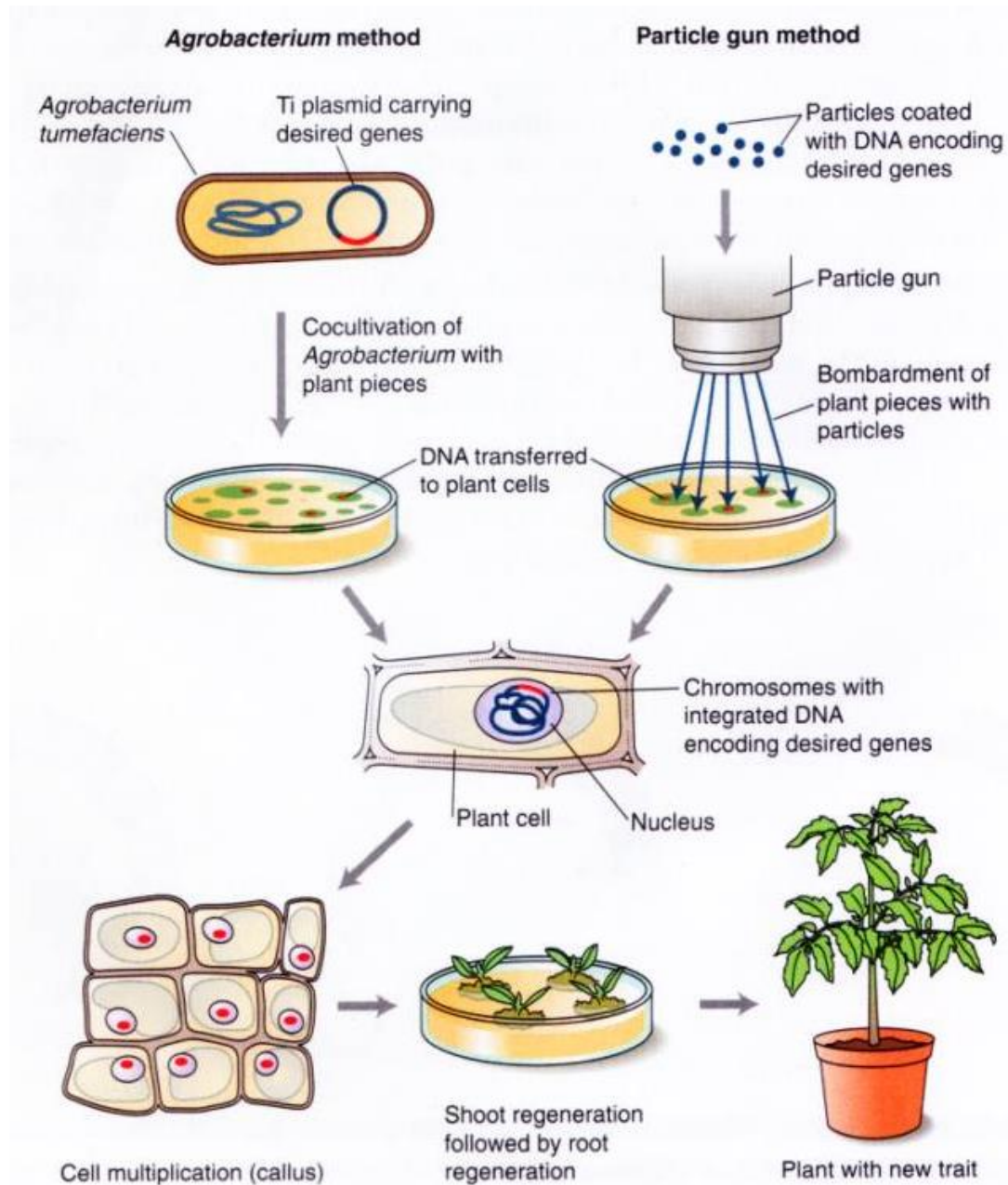

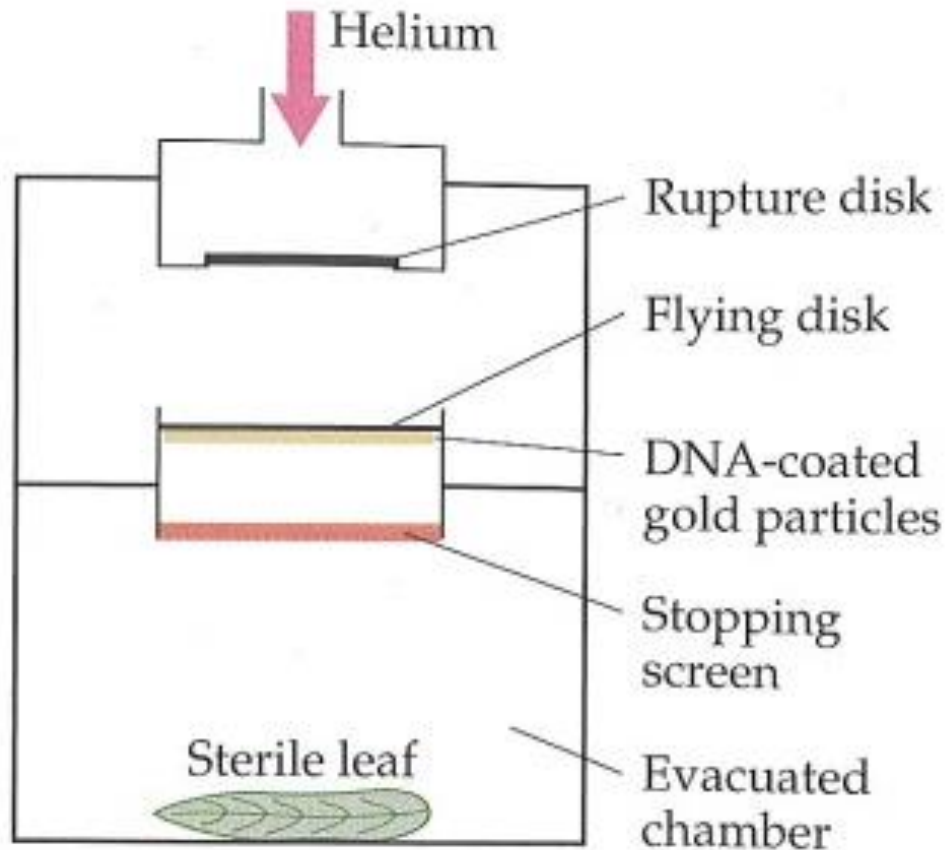

FIGURE 18.10 Schematic representation of a microprojectile bombardment apparatus. When the helium pressure builds up to a certain point, the plastic rupture disk bursts, and the released gas accelerates the flying disk with the DNA-coated gold particles on its lower side. The gold particles pass the stopping screen, which holds back the flying disk, and penetrate the cells of the sterile leaf.

TABLE 18.5 Plant cell reporter and selectable marker gene systems

Enzyme activity	Selectable marker	Reporter gene
Neomycin phosphotransferase	Yes	Yes
Hygromycin phosphotransferase	Yes	Yes
Dihydrofolate reductase	Yes	Yes
Chloramphenicol acetyltransferase	Yes	Yes
Gentamicin acetyltransferase	Yes	Yes
Nopaline synthase	No	Yes
Octopine synthase	No	Yes
β -Glucuronidase	No	Yes
Streptomycin phosphotransferase	Yes	Yes
Bleomycin resistance	Yes	No
Firefly luciferase	No	Yes
Bacterial luciferase	No	Yes
Threonine dehydratase	Yes	Yes
Metallothionein II	Yes	Yes
<i>enol</i> -Pyruvylshikimate-3-phosphate synthase	Yes	No
Phosphinothricin acetyltransferase	Yes	Yes
β -Galactosidase	No	Yes
Blasticidin S deaminase	Yes	Yes
Acetolactate synthase	Yes	No
Bromoxynil nitrilase	Yes	No
Green fluorescent protein	No	Yes

Adapted from Walden and Schell, *Eur. J. Biochem.* **192**:563–576, 1990, and Gruber and Crosby, p. 89–119, in B. R. Glick and J. E. Thompson (ed.), *Methods in Plant Molecular Biology and Biotechnology* (CRC Press, Boca Raton, FL, 1993).

Agrobacterium tumefaciens Ti Plasmid based DNA Transfer System

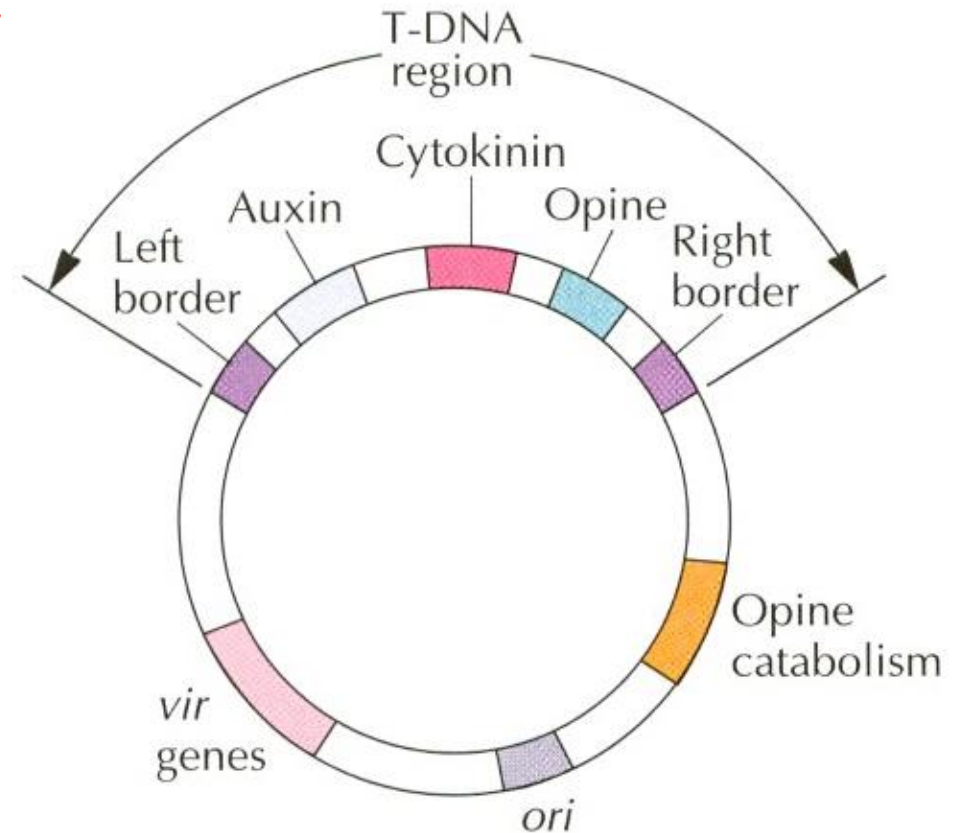
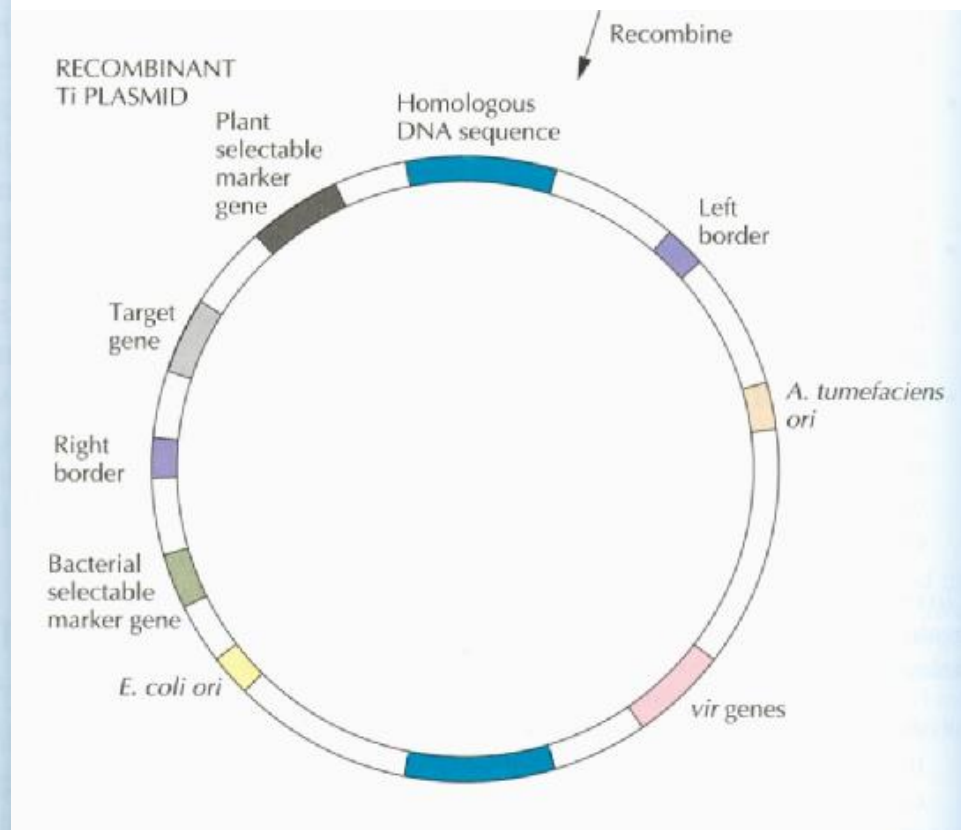
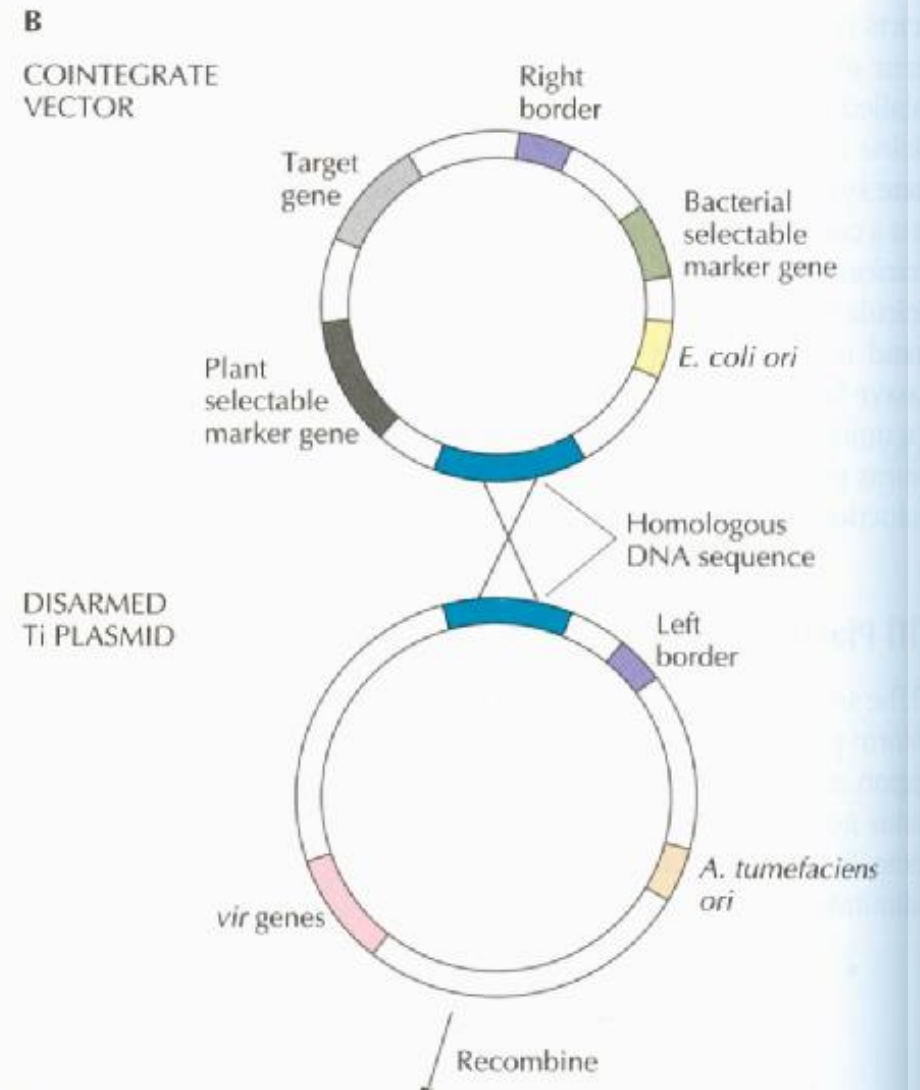

Figure 17.3 Schematic representation of a Ti plasmid. The T-DNA is defined by its left and right borders and includes genes for the biosynthesis of auxin, cytokinin, and an opine; these genes are transcribed and translated only in plant cells. Outside of the T-DNA region, there is a cluster of *vir* genes, a gene(s) that encodes an enzyme(s) for opine catabolism, and an origin of DNA replication (*ori*) which permits the plasmid to be stably maintained in *A. tumefaciens*. None of these features is drawn to scale.

Agrobacterium tumefaciens Ti Plasmid based DNA Transfer System



Agrobacterium tumefaciens Ti Plasmid based DNA Transfer System

Cointegrate Vector System

(B) The cointegrate cloning vector (top) carries only an *E. coli* origin of replication and cannot exist autonomously within *A. tumefaciens*. It also contains a selectable marker that can be used in either *E. coli* or *A. tumefaciens*, a T-DNA right border, a plant selectable marker (reporter) gene, a target gene, and a sequence of Ti plasmid DNA that is homologous to a segment on the disarmed Ti plasmid. The disarmed Ti plasmid (middle) contains the T-DNA left border, the *vir* gene cluster, and an *A. tumefaciens* *ori*. Following recombination between the cointegrate cloning vector and the disarmed Ti plasmid, the final recombinant plasmid (bottom) has the T-DNA left and right borders bracketing the cloned and plant reporter genes.

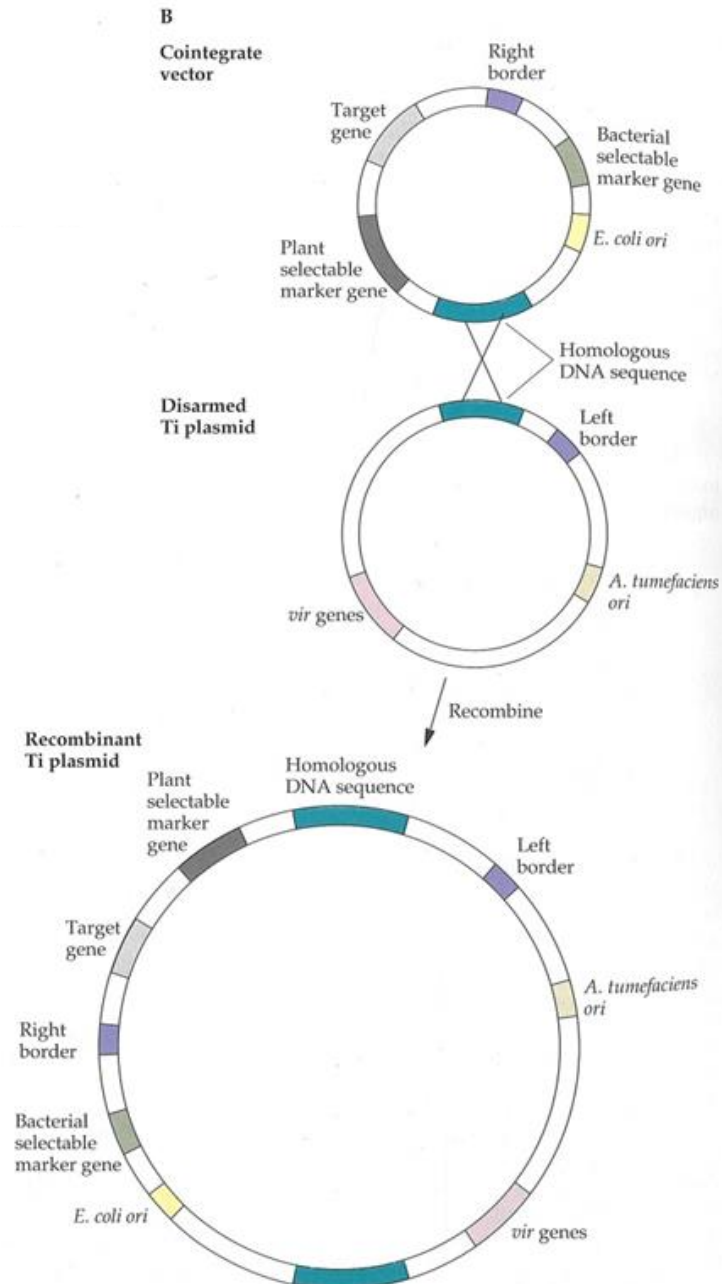

Agrobacterium tumefaciens Ti Plasmid based DNA Transfer System

Binary Vector System

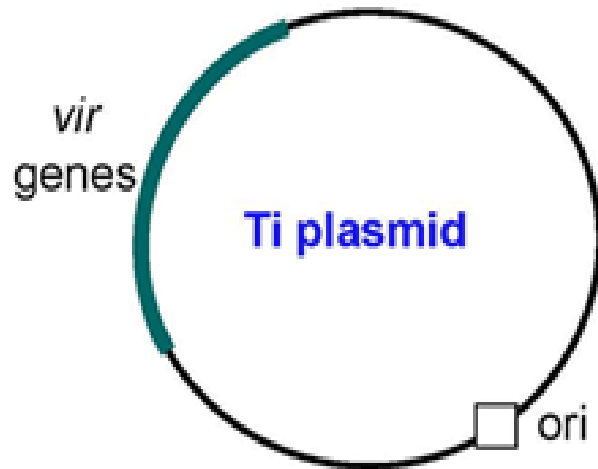

Disarmed Ti-Helper Plasmid

The helper plasmid contains the vir genes that originated from the Ti plasmid of Agrobacterium. These genes code for a series of proteins that cut the binary plasmid at the left and right border sequences, and facilitate transduction of the T-DNA to the host plant's cells. The helper plasmid also contains a BSM and an ori for bacteria

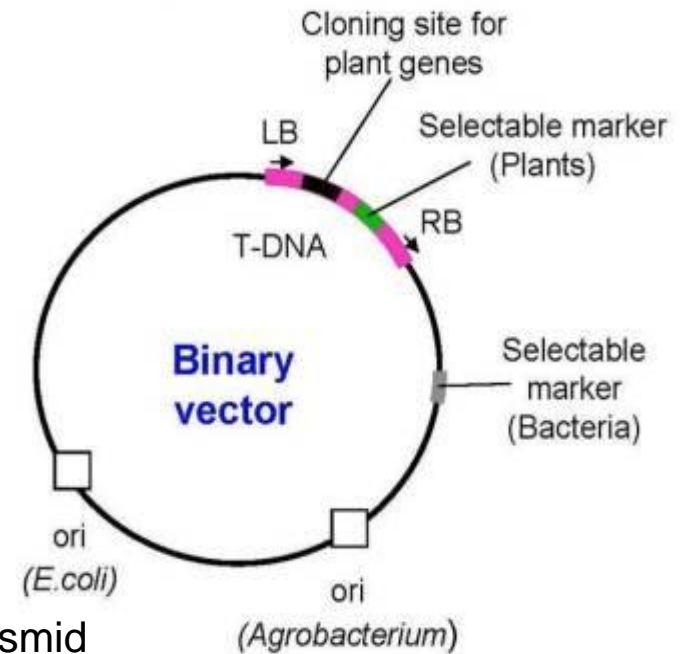

Binary plasmid

The T-DNA portion of the binary plasmid is flanked by left and right border sequences and consists of a transgene as well as a plant selectable marker (PSM). Outside of the T-DNA, the binary plasmid also contains a bacterial selectable marker (BSM) and an origin of replication (ori) for bacteria

FIGURE 18.25 Schematic representation of a T-DNA-based selectable marker gene excision system. Following integration of the T-DNA into the plant chromosomal DNA, the transposase can excise the selectable marker gene and insert it into a different chromosomal location. LB, the T-DNA left border; RB, the T-DNA right border. The promoter and transcription termination sequences of the genes are not shown.

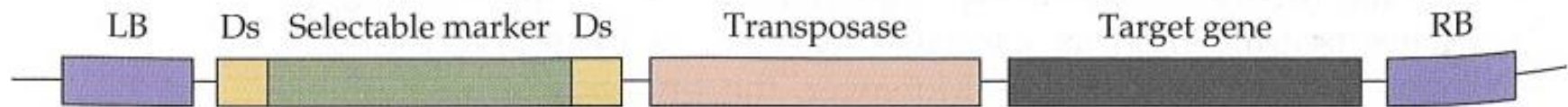

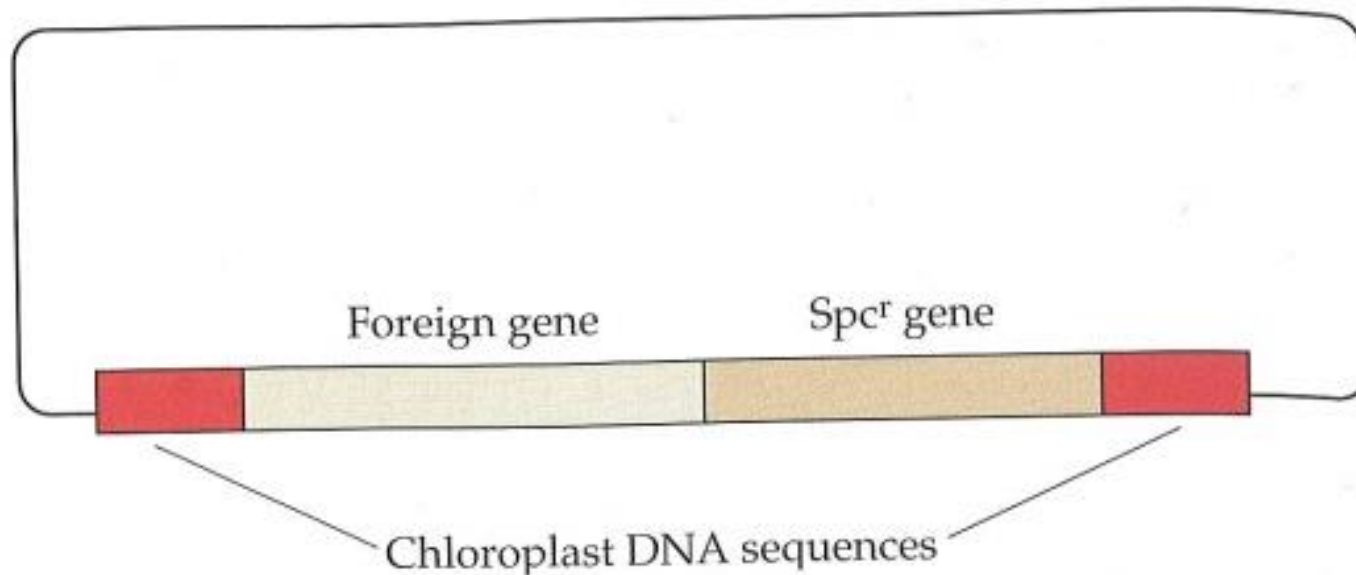

FIGURE 18.12 Plasmid vector used for integrating a foreign gene and a marker gene into the chloroplast genome. Regulatory sequences are not shown. Homologous recombination can occur between chloroplast DNA sequences on the vector and the chloroplast genome. Spc^r , spectinomycin resistance.

Features of Transgenic Plants

Plant	Insect resistance	Herbicide Resistance	Virus Resistance	Male Sterility	Product Composition	Others
Maize	yes	yes		yes		
Cotton	yes	yes				
Canaola	yes	yes				
Tomato	yes					Ripening retard.
Potato	yes		yes		Starch	
Soybean		yes			Fatty Acids	
Tobacco		yes				
Sugar Beet		yes				
Chicoree		yes		yes		
Rice		yes			carotene	
Zucchini			yes			
Melon			yes			Ripening retard.
Flowers					Color	Stability

Herbicide resistance



Abbildung 6.10: Herstellung herbizidresistenter Pflanzen. Falls die T-DNA von *Agrobacterium* bakterielle DNA enthält, die für das Photosyntheseenzym EPSPS mit einer Chloroplastenzielsequenz codiert, kann sie in eine Pflanze übertragen werden. Wenn der CaMV-Promotor aktiviert wird, kann die Pflanze (hier Tabak) das bakterielle EPSPS-Enzym herstellen und hohen Konzentrationen Glyphosat widerstehen, die sonst das natürlicherweise in den Pflanzen enthaltene Enzym hemmen würden. Auf diese Weise können sowohl Pflanzen wie Unkräuter mit Glyphosat besprüht werden, und nur die nichttransformierten Pflanzen werden davon betroffen.

TABLE 19.3 Some examples of gene-based herbicide resistance

Herbicide(s)	Mode of development of herbicide resistance
Triazines	Resistance is due to an alteration in the <i>psbA</i> gene, which codes for the target of this herbicide, chloroplast protein D-1.
Sulfonylureas	Genes encoding resistant versions of the enzyme acetolactate synthetase have been introduced into poplar, canola, flax, and rice.
Imidazolinones	Strains with resistant versions of the enzyme acetolactate synthetase have been selected in tissue culture.
Aryloxyphenoxypropionates, cyclohexanediones	These herbicides inhibit the enzyme acetyl coenzyme A carboxylase. Resistance, selected in tissue culture, is due either to an altered enzyme that is not herbicide sensitive or to the degradation of the herbicide.
Glyphosate	Resistance is from overproduction of EPSPS, the target of this herbicide. Resistance has been engineered by transforming soybean with the gene for a glyphosate-resistant EPSPS and tobacco with a glyphosate oxidoreductase gene, which encodes an enzyme that degrades glyphosate.

Bromoxynil

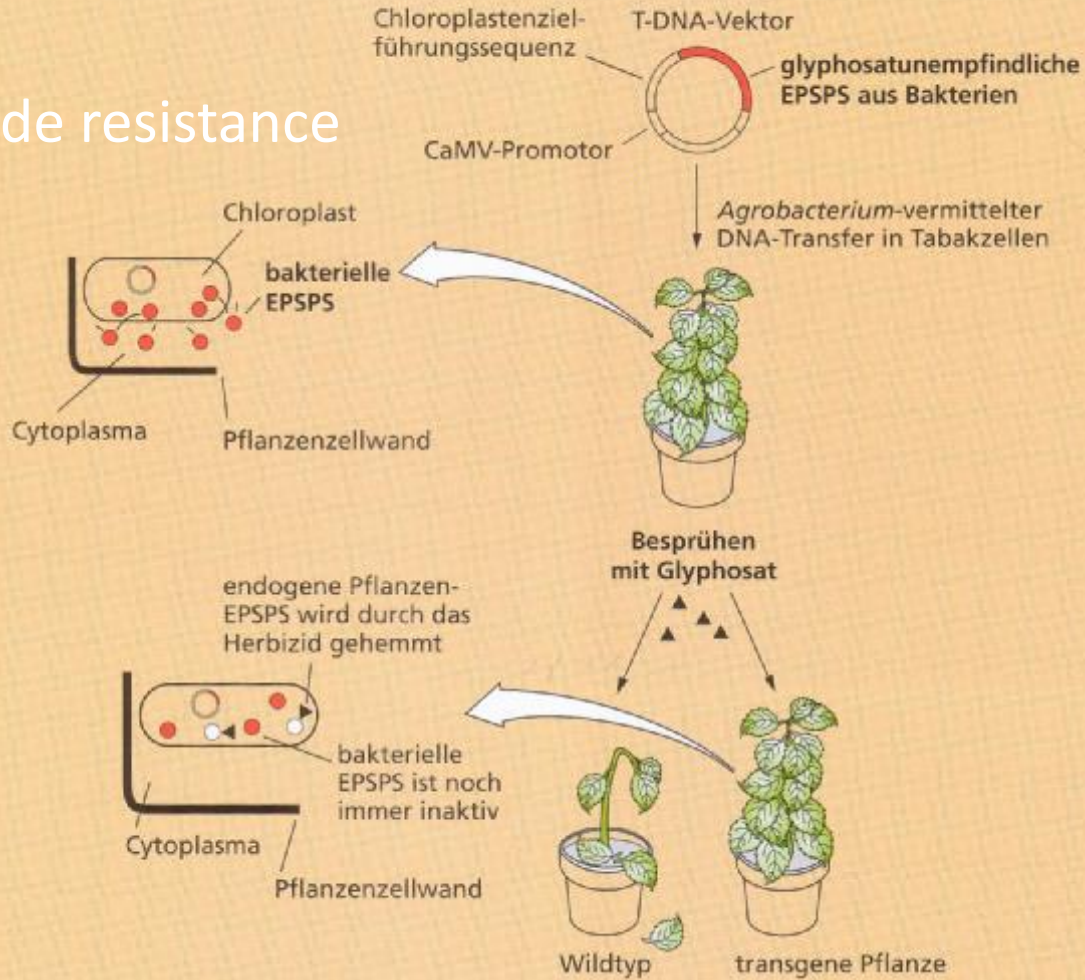
Resistance to this photosystem II inhibitor has been created by transforming tobacco and cotton plants with a bacterial nitrilase gene, which encodes an enzyme that degrades this herbicide.

Phenoxy-carboxylic acids
(e.g., 2,4-D and 2,4,5-T)

Resistant cotton and tobacco plants have been created by transformation with the *tfdA* gene from *Alcaligenes*, which encodes a dioxygenase that degrades this herbicide.

Glufosinate
(phosphinothricin)

Over 20 different plants have been transformed with either the *bar* gene from *Streptomyces hygroscopicus* or the *pat* gene from *S. viridochromogenes*. The phosphinothricin acetyltransferase that these genes encode detoxifies this herbicide.

Cyanamide

Resistant tobacco plants were produced when a cyanamide hydratase gene from the fungus *Myrothecium verrucaria* was introduced. The enzyme encoded by this gene converts cyanamide to urea.

Dalapon

Tobacco plants transformed with a dehalogenase gene from *Pseudomonas putida* can detoxify this herbicide.

Herbicide resistance

Glyphosate

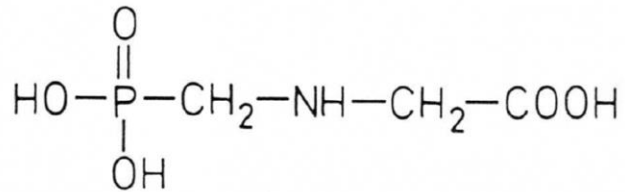

Resistance by overproduction of a resistant EPSPS variant

Resistance by enzymatic degradation catalyzed by a glyphosphate oxidoreductase

Resistance by Acetylation

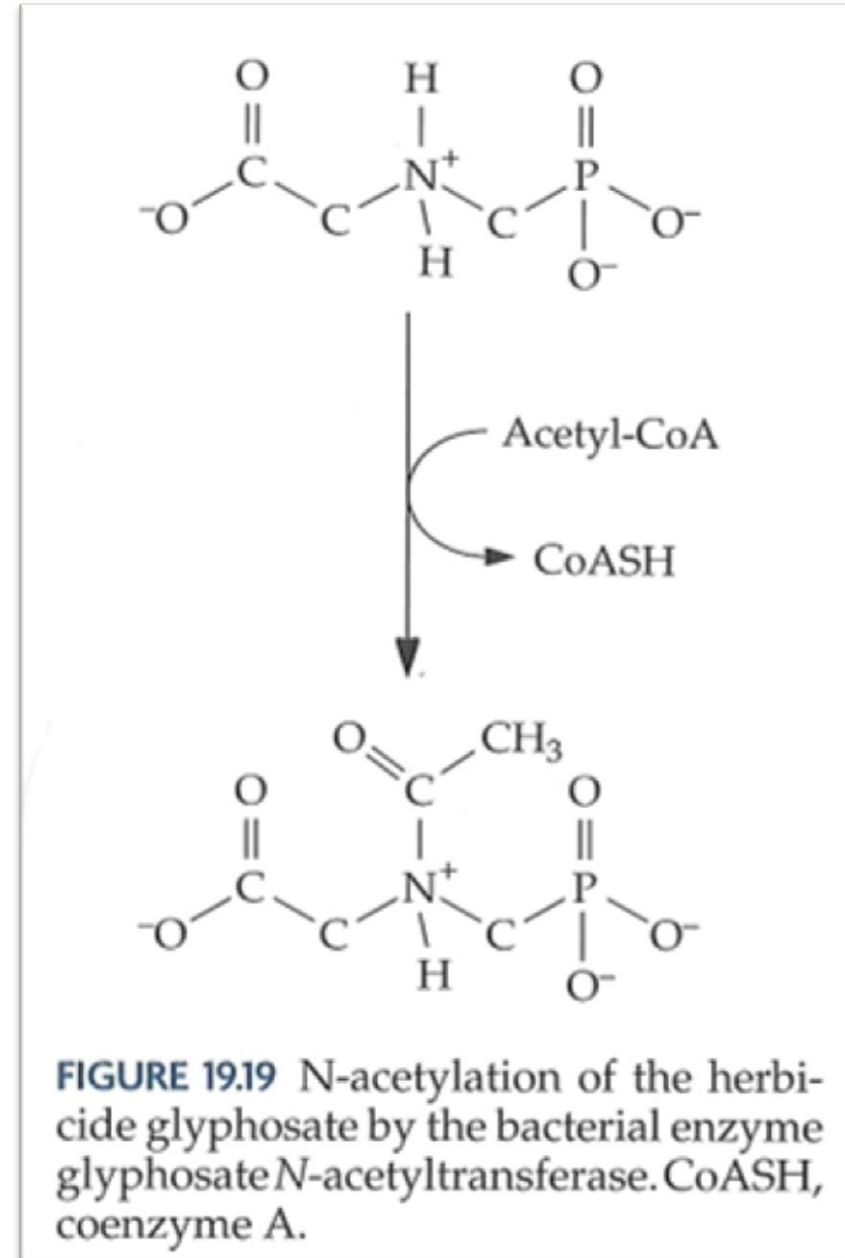

Roundup-Ready Sojabohne

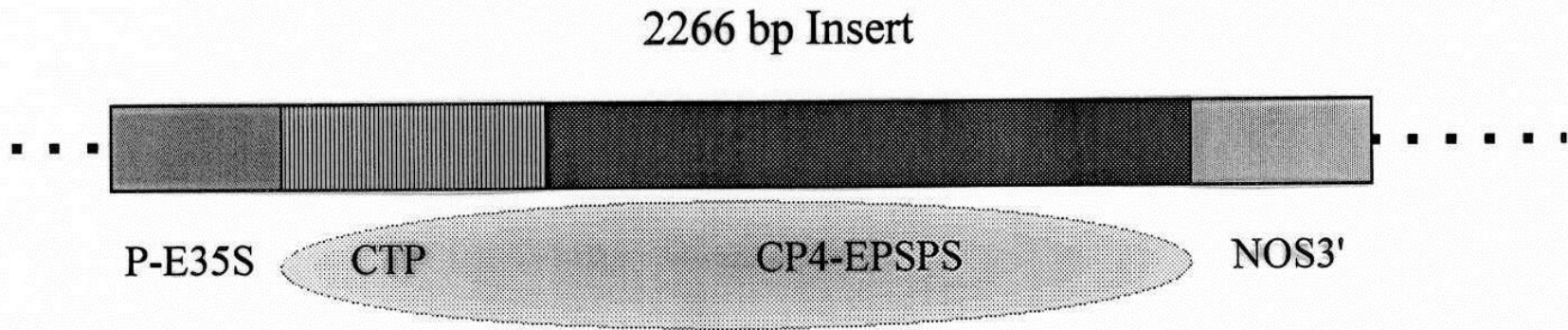

P-E35S

E35S promoter

CTP

chloroplast transpeptidase (transport into chloroplasts)

CP4-EPSPS

5-enolpyruvylshikimate-3-phosphate synthase

NOS3'

terminator of nopaline synthase gene

Herbicide resistance

Glufosinate
(Phosphinothricin)

Inactivation by acetylation

Phosphinothricin acetyltransferase

(bar gene from *Streptomyces hygrosopicus*
pat gene from *S. viridochromogenes*)

Abb. 165. Phosphinothricin (PPT) als Hemmstoff der Glutaminsynthetase (GS).

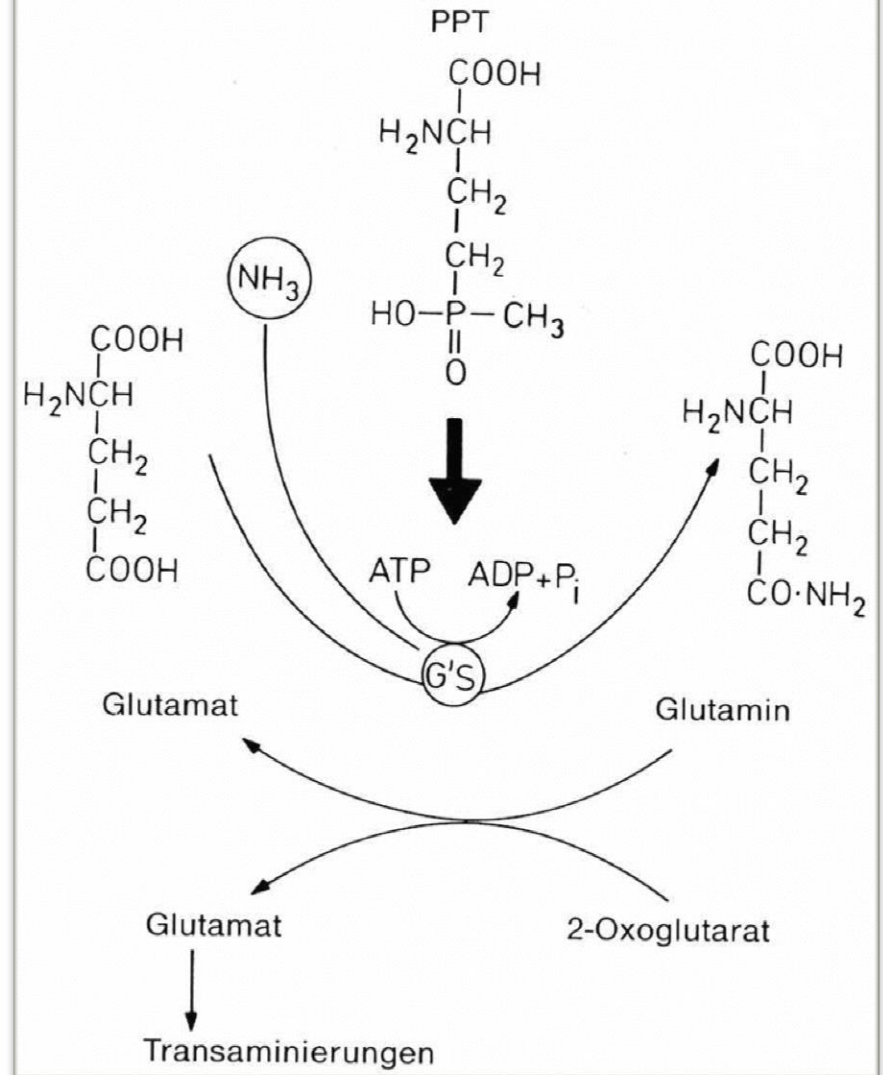
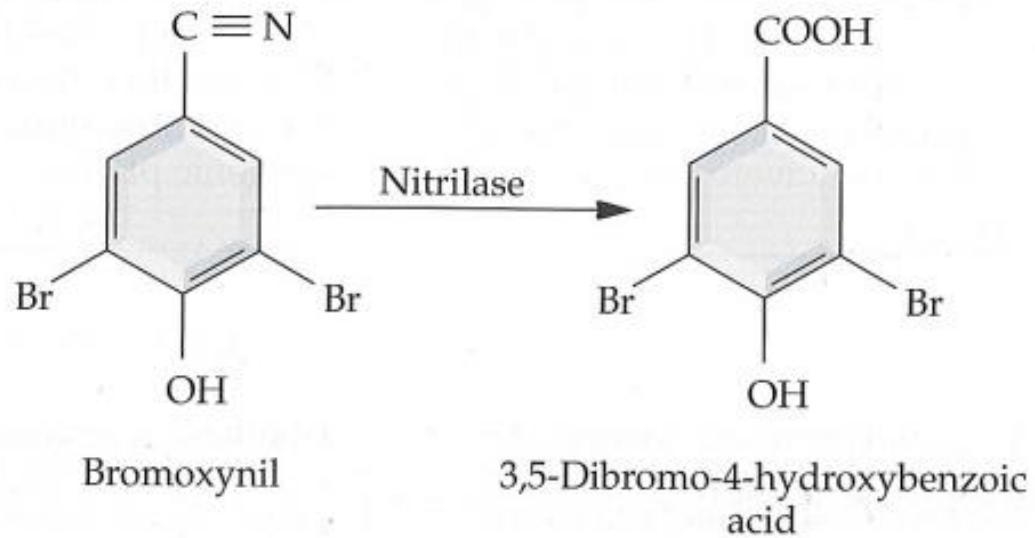

FIGURE 19.22 Detoxification of the herbicide bromoxynil by the enzyme nitrilase from *K. ozaenae*.



Bt-Toxins

- Proteins derived from *Bacillus thuringiensis* that specifically act against insects
- Act in the intestine of insects
- No toxicity on higher organisms
- Bt-toxin has long history of use as insecticide – spraying of protein preparations obtained by fermentation of *B.thuringiensis* strains
- officially accepted in organic farming

Bacillus thuringiensis Toxin

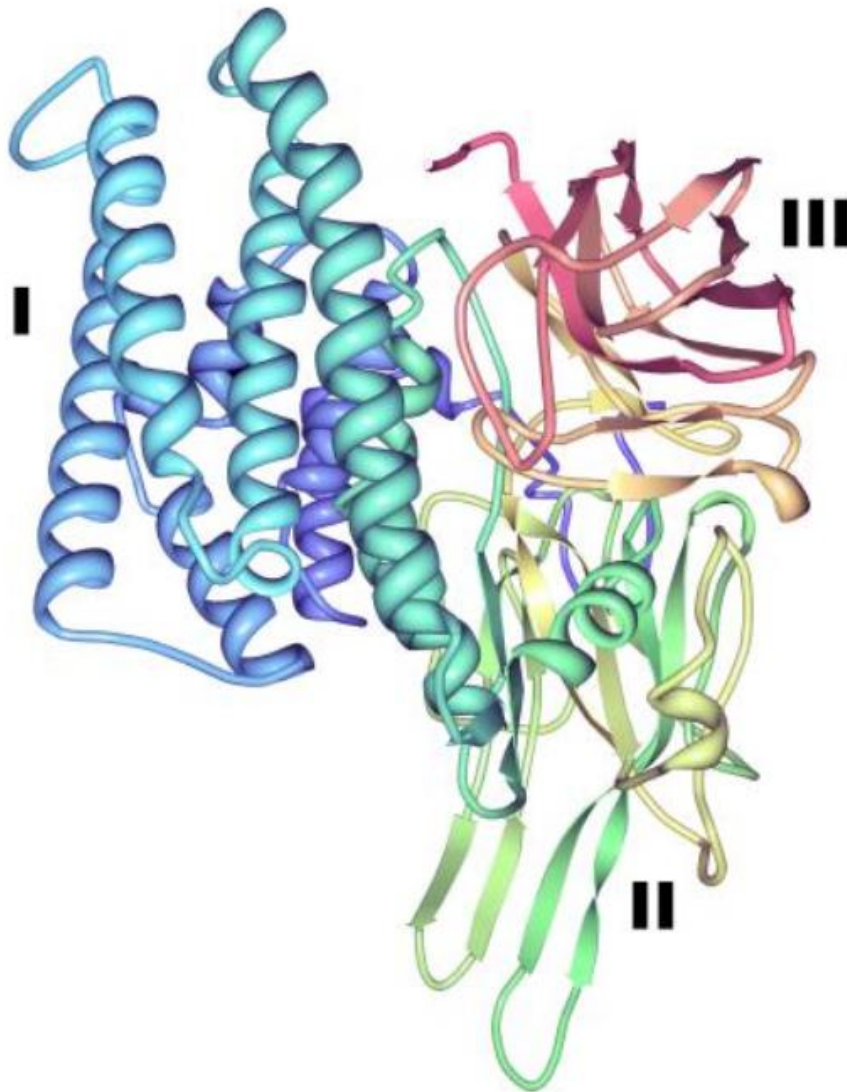

Cry toxins belonging to the three domain Cry toxin family, display clear differences in their amino acid sequences but all share in common a remarkably similar and conserved three domain structure.

Fig. 4: Three dimensional structure of Cry2Aa toxin. This structure from PDB accession number 1I5P is representative of a three domain toxin produced by Bt. Roman numerals indicate the typical domains of the three domain Cry proteins. I perforating domain; II central domain; involved in toxin receptor interactions; III galactose binding domain; involved in receptor binding and pore formation.

Bacillus thuringiensis (Bt)

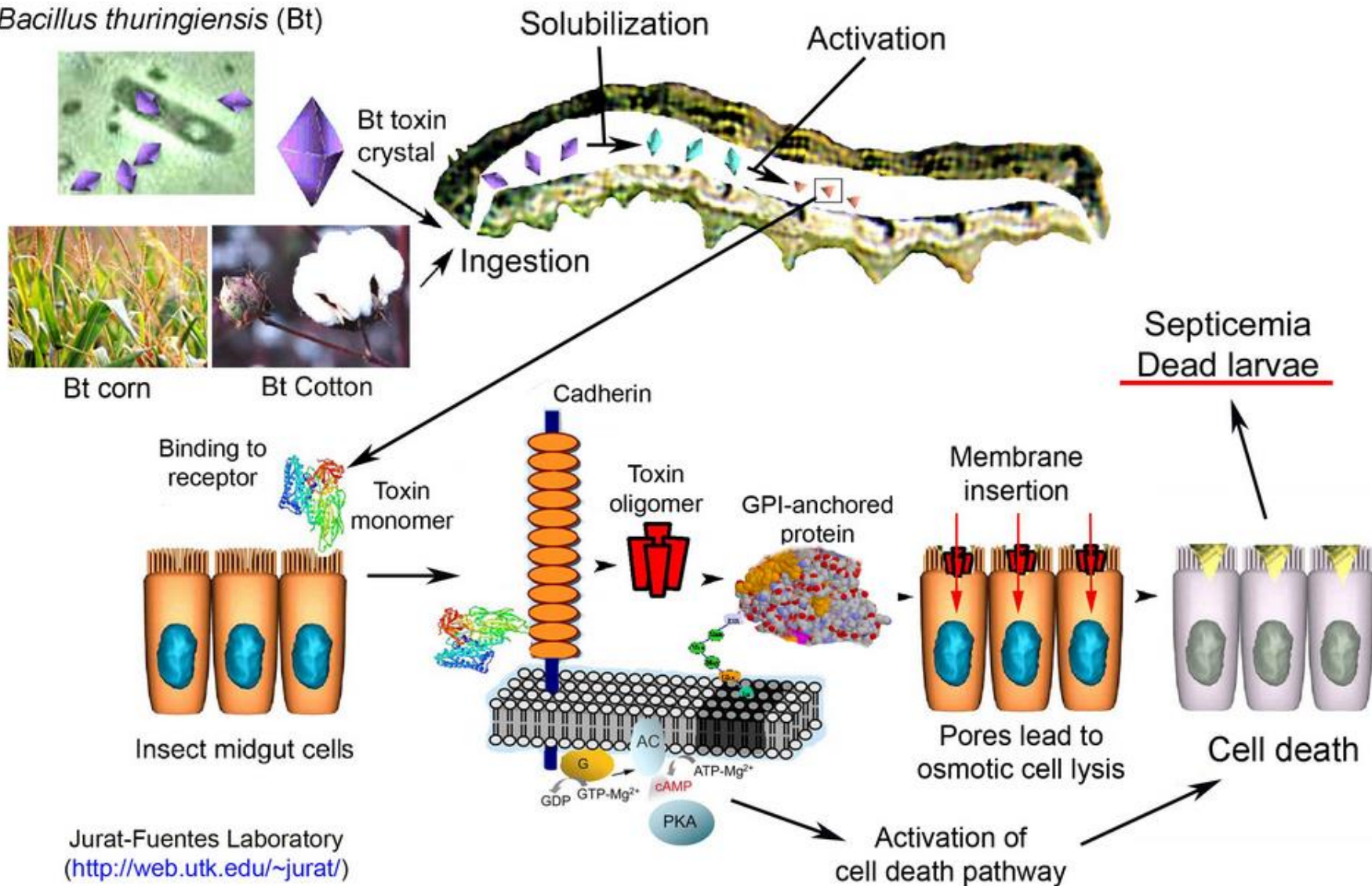

Models of the mode of action of Cry toxins

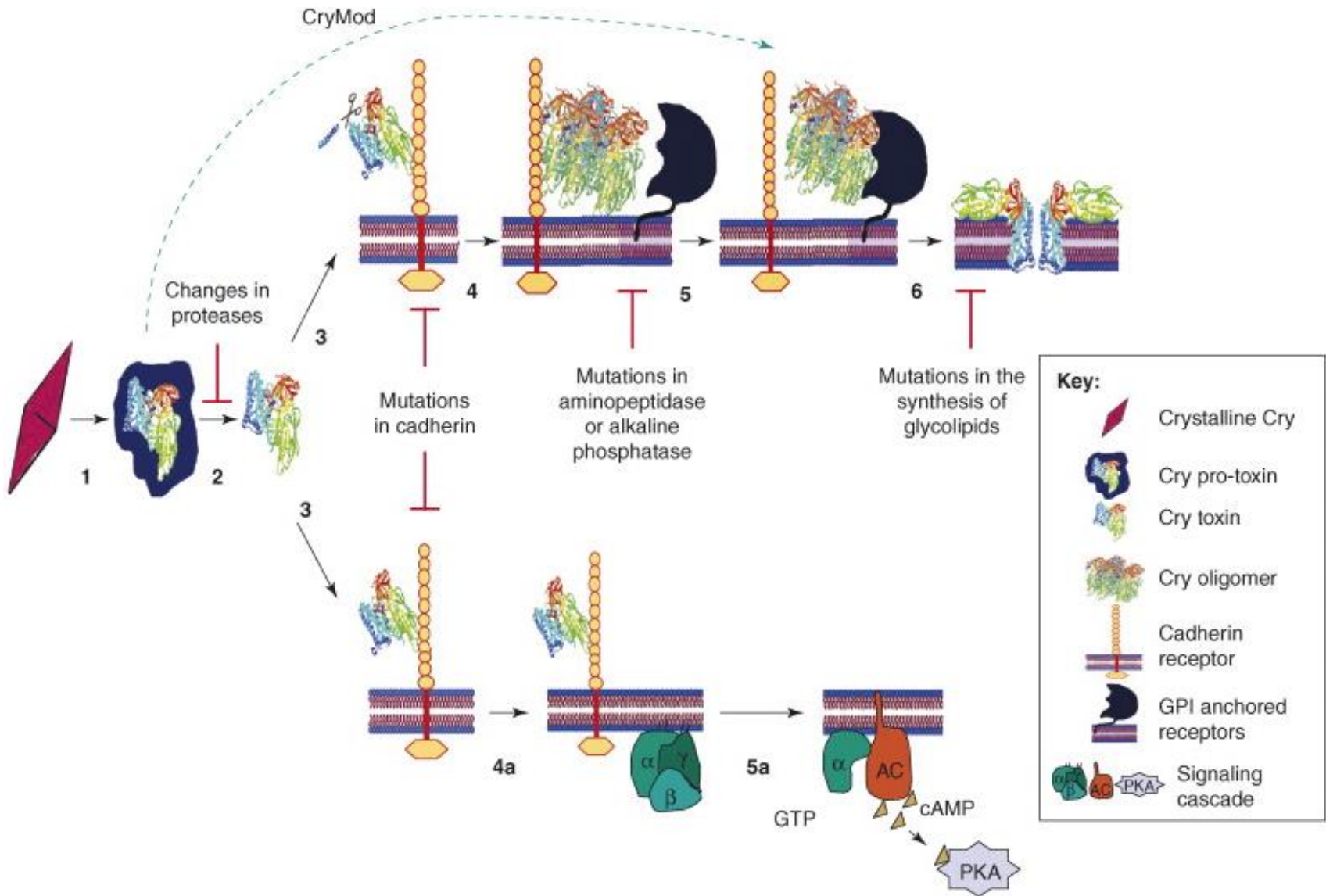

Figure 2. Models of the mode of action of Cry toxins and resulting mechanism for resistance. Two different mechanisms can be distinguished: the pore-formation model (top) and the signal transduction model (bottom), which both include similar initial steps for toxin solubilization in midgut lumen (1), activation by midgut proteases (2), and binding to primary receptor cadherin (3). In the pore-formation model (top), step 3 induces the cleavage of helix α -1 and triggers toxin oligomerization (4). The toxin oligomer then binds to a secondary receptor, such as aminopeptidase or alkaline phosphatase, which are anchored by a glycosylphosphatidylinositol anchor in the membrane (5). Finally, the toxin inserts itself into the membrane, thereby forming a pore that kills the insect cells (6). The signal transduction model (bottom) proposes that the interaction of the Cry toxin with a cadherin receptor triggers an intracellular cascade pathway that is mediated by activation of protein G (4a), which, in a subsequent step (5a), activates adenylyl cyclase. This signal then increases the levels of cyclic adenosine monophosphate, which activates protein kinase A and leads to cell death. See Refs [13](#), [15](#), [16](#), [17](#), [18](#), [19](#), [20](#), [51](#), [52](#), [53](#) and [54](#) for the different mechanisms that have resulted in toxin resistance in several insects. The CryMod toxins, in which helix α -1 is deleted, avoid resistance by bypassing cadherin interaction [\[38\]](#).

Target Specificity - Overview

Pathotype A

- *B.t. sv. kurstaki* (*B.t.k.*) act against larvae of *Lepidoptera* (order of insects that includes moths and butterflies) , not against *Noctuidae* (Eulenfalter, owlet moths)
- *B.t. sv. aizawai* (*B.t.a.*) act against larvae of distinct *Lepidoptera* , also against *Noctuidae* (Eulenfalter owlet moths)

Pathotype B

- *B.t. sv. israelensis* (*B.t.i.*) act against larvae of distinct *Diptera* (*Diptera*, from the Greek di = two, and ptera = wings)

Pathotype C

- *B.t. v. tenebrionis* (*B.t.t.*) act against larvae of distinct *Chrysomelidae* (commonly known as leaf beetles)

TABLE 19.1 Expression of some *B. thuringiensis* insecticidal toxin genes in transgenic plants

Plant(s)	Gene	% Expression	Insecticidal
Tobacco	<i>cry1Ab</i> , full	0.0001–0.0005	No
Tobacco	<i>cry1Ab</i> , truncated	0.003–0.012	Yes
Tobacco	<i>cry1Aa</i> , full	Not detected	No
Tobacco	<i>cry1Aa</i> , truncated	0.00125	Yes
Tobacco	<i>cry1Ac</i> , truncated	<0.014	Yes
Tomato	<i>cry1Ab</i> , truncated	0.0001	Yes
Cotton	<i>cry1Ab</i> , truncated, WT	<0.002	No
Cotton	<i>cry1Ab</i> , truncated, PM	0.05–0.1	Yes
Tomato, tobacco	<i>cry1Ab</i> , truncated, WT	0.002	Yes
Tomato, tobacco	<i>cry1Ab</i> , truncated, PM	0.002–0.2	Yes
Tomato, tobacco	<i>cry1Ab</i> , truncated, FM	0.3	Yes

Adapted from Ely, p. 105–124, in Entwistle et al. (ed.), *Bacillus thuringiensis, an Environmental Biopesticide: Theory and Practice* (John Wiley & Sons, Chichester, United Kingdom, 1993).

Terms and abbreviations: full, the complete protoxin gene; truncated, a shortened version of the protoxin gene; WT, wild-type codons; PM, partially modified codons; FM, fully modified codons.

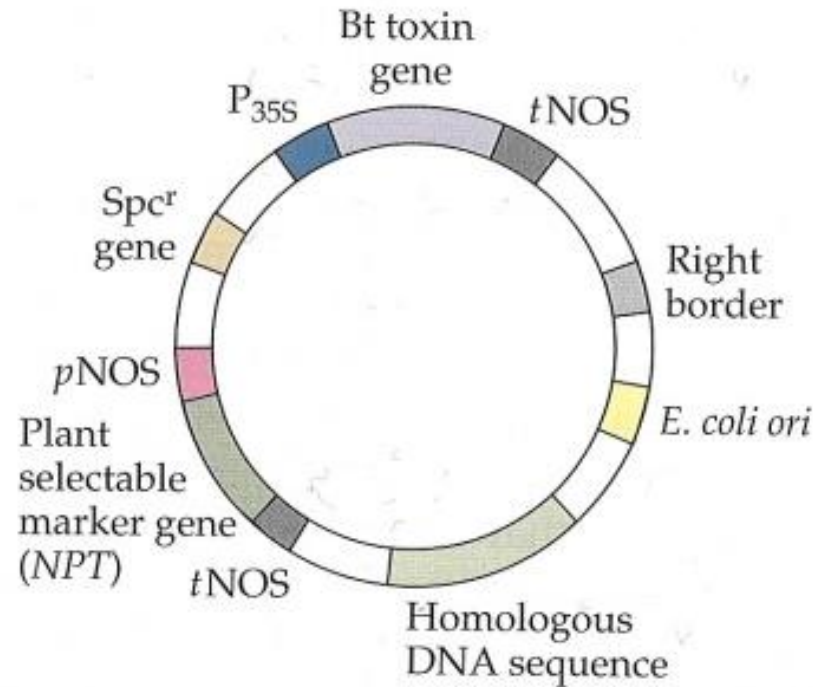

FIGURE 19.1 Cointegrate cloning vector carrying a *B. thuringiensis* (Bt) insecticidal-toxin gene. The toxin gene is under the control of the strong, constitutive 35S promoter (P_{35S}) from cauliflower mosaic virus and the nopaline synthase transcription terminator–polyadenylation site ($tNOS$). The vector has an *E. coli* origin of DNA replication (*ori*) and an Spc^r gene, which allow the vector to be maintained and selected in *E. coli* cells; a T-DNA right border; a plant selectable marker gene; and a region of DNA that is homologous to DNA in the disabled Ti plasmid, for integrating the two plasmids. The neomycin phosphotransferase gene (*NPT*), which acts as a plant reporter gene, is under the transcriptional control of nopaline synthase gene sequences ($pNOS$ and $tNOS$) and is used to select for kanamycin-resistant transformed plant cells.

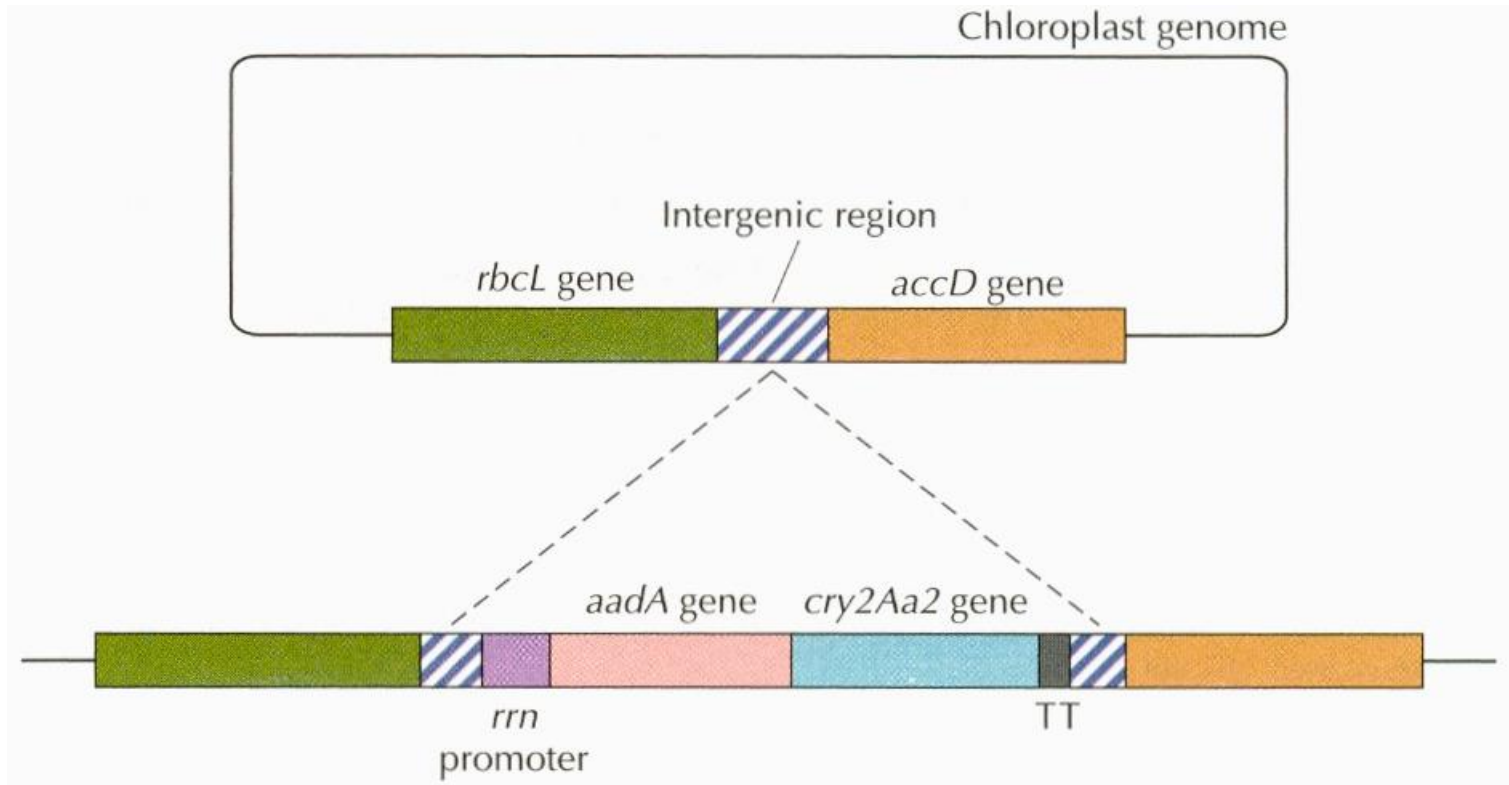

FIGURE 19.2 Site on the chloroplast genome where a foreign gene encoding the *B. thuringiensis* Cry2Aa2 protoxin is integrated by homologous recombination. The genes *rbcL* and *accD* are both present in a single copy per chloroplast genome. The intergenic region between these two genes, which is the site of insertion of the foreign genes, is smaller than it appears in this representation. The *aadA* gene (encoding spectinomycin and streptomycin resistances) and the *cry2Aa2* gene are both under the transcriptional control of the constitutive chloroplast *rrn* promoter and transcription terminator (TT), and each contains its own ribosomal binding site. Integration of foreign DNA into the intergenic spacer region prevents insertion of a foreign gene from interfering with the expression of any endogenous chloroplast genes. Adapted from Kota et al., *Proc. Natl. Acad. Sci. USA* **96**:1840–1845, 1999.

Transgenic Bt-maize - Benefits

Harvest losses due to *Ostrinia nubilalis* (corn borer, Maiszünsler)

In USA: 20% of total harvests (15 mio t/year)

→ = 200 % of Canada's maize production

Savings by Bt-Maize

- 2.5 mio ha land
- 100,000 t fertilizer
- 100 mio litres of fuel
- Chemical plant protection agents

Data from Novartis

Biological Insect Control

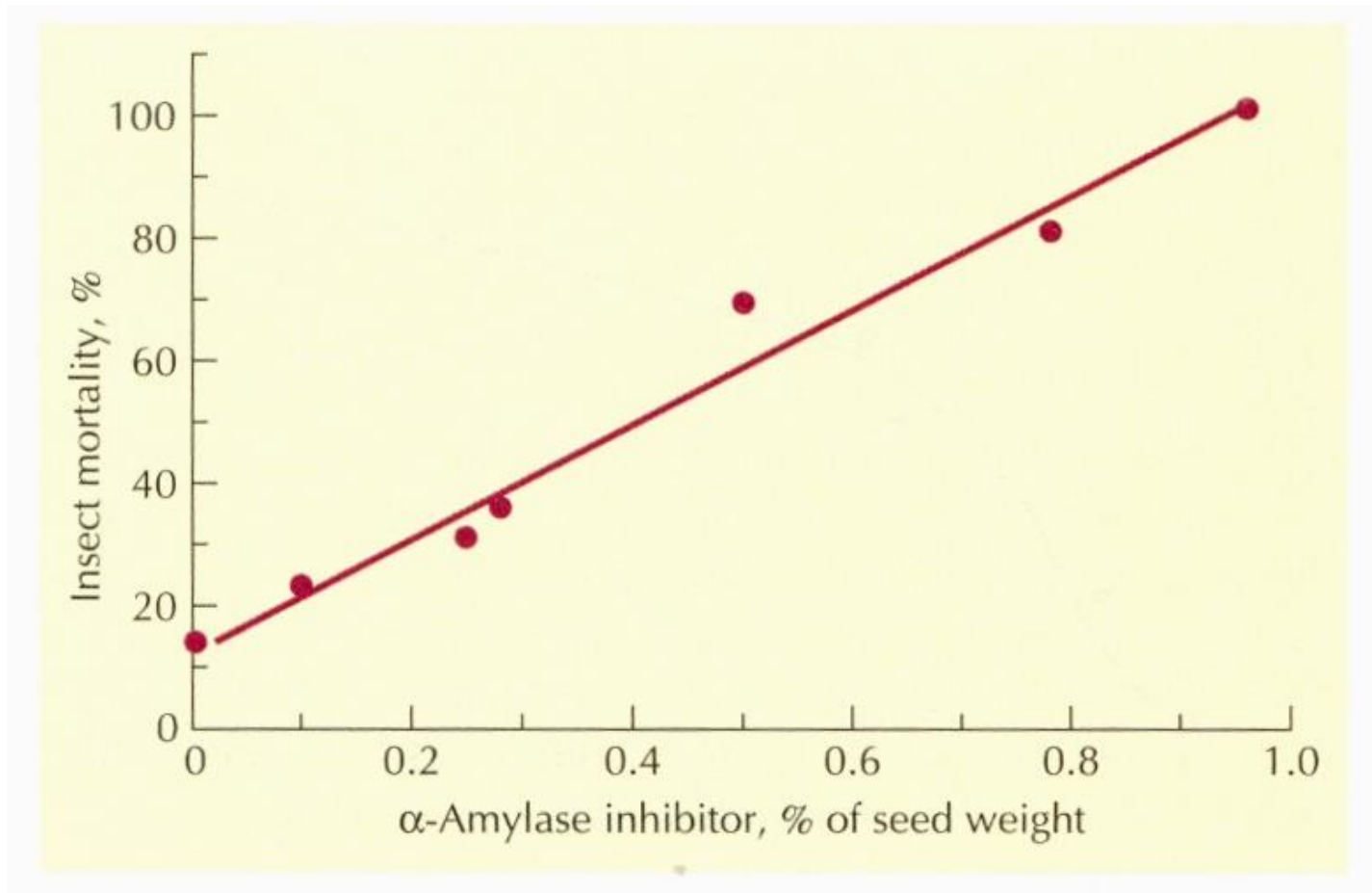
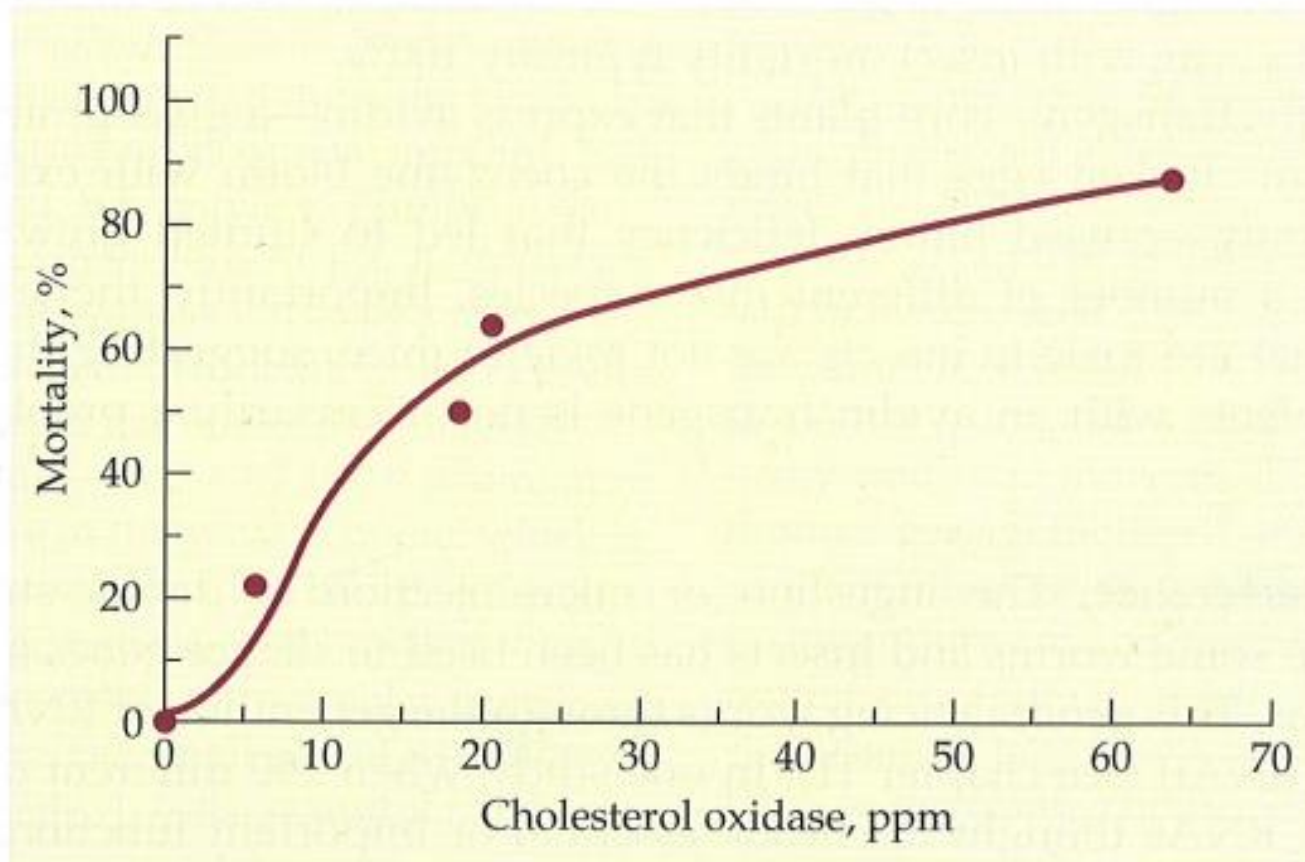

FIGURE 19.5 Mortality of cowpea weevil larvae reared on transgenic pea plants that produce different amounts of α -amylase inhibitor.

Biological Insect Control

FIGURE 19.6 Effect of increasing amounts of cholesterol oxidase on the mortality of boll weevil larvae. ppm, parts per million. Adapted from Corbin et al., *Appl. Environ. Microbiol.* **60**:4239–4244, 1994.



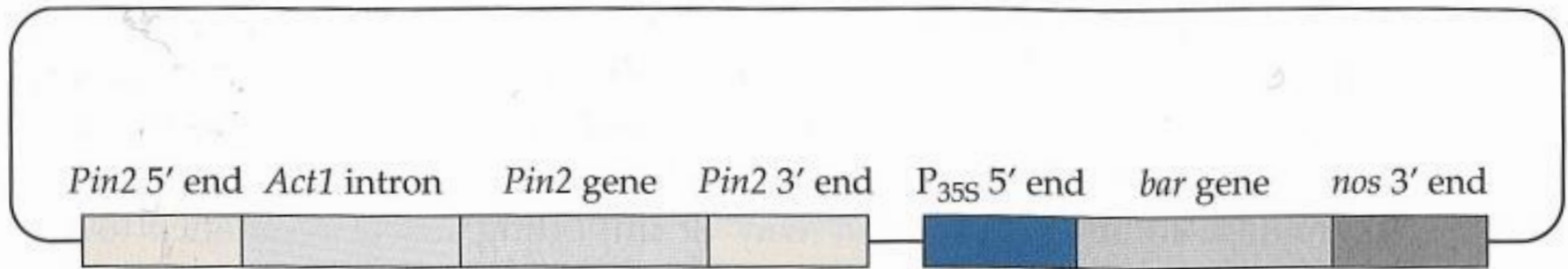

FIGURE 19.4 Plasmid vector carrying the potato proteinase inhibitor II gene (*Pin2*). 5' end, the region of DNA preceding the gene; 3' end, the region of DNA following the gene; *Act1* intron, the first intron from the rice actin 1 gene; P_{35S} 5' end, the 35S promoter from cauliflower mosaic virus; *bar* gene, the bacterial phosphinothricin acetyltransferase gene; *nos* 3' end, the region of DNA following the nopaline synthase gene. The *bar* gene serves as a selectable marker for transgenic plants, conferring resistance to the herbicide Basta (ammonium glufosinate).

Modification of Products

TABLE 20.3 Transgenic canola varieties with modified seed lipid contents

Seed product	Commercial use(s)
40% Stearic acid	Margarine, cocoa butter
40% Lauric acid	Detergents
60% Lauric acid	Detergents
80% Oleic acid	Food, lubricants, inks
Petroselinic	Polymers, detergents
“Jojoba” wax	Cosmetics, lubricants
40% Myristate	Detergents, soaps, personal care items
90% Erucic acid	Polymers, cosmetics, inks, pharmaceuticals
Ricinoleic acid	Lubricants, plasticizers, cosmetics, pharmaceuticals

Adapted from Murphy, *Trends Biotechnol.* **14**:206–213, 1996.

Antisense-Technique

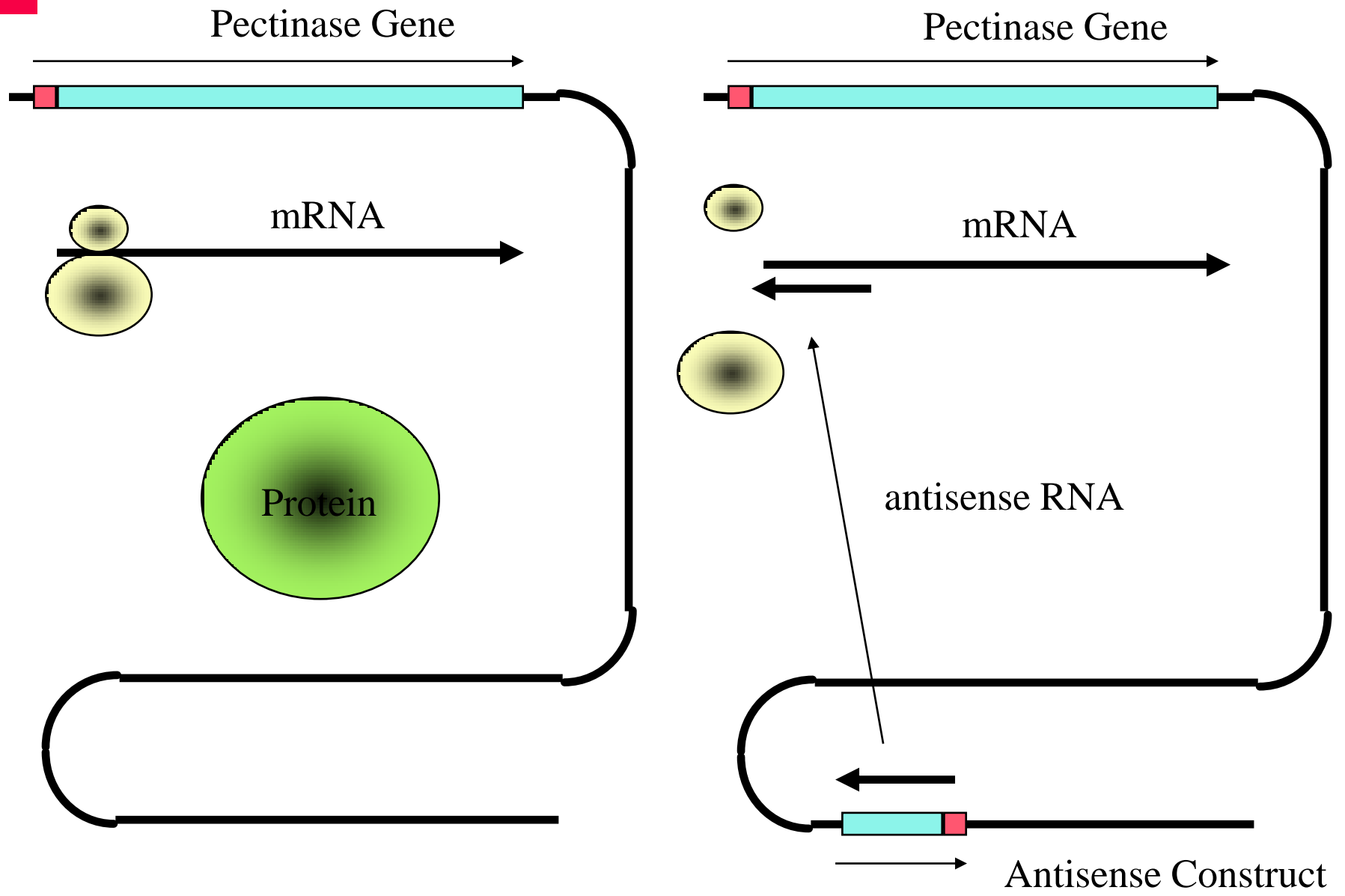

Transgenic Tomato

In the UK, Zeneca produced a tomato paste that used technology similar to the Flavr Savr.[6] Don Grierson was involved in the research to make the genetically modified tomato.[7] Due to the characteristics of the tomato, it was cheaper to produce than conventional tomato paste, resulting in the product being 20% cheaper. Between 1996 and 1999, 1.8 million cans, clearly labelled as genetically engineered, were sold in Sainsbury's and Safeway. At one point the paste outsold normal tomato paste but sales fell in the autumn of 1998

Transgenic Potato

Antisense strategy: blocking enzyme synthesis

Researchers at BASF Plant Science have now developed a new starch potato (under the brand name Amflora), which produces starch composed almost exclusively of amylopectin. Using the antisense strategy, they switched off the gene for the starch synthase enzyme, which is involved in the synthesis of amylose, by inserting a mirror image of the gene ('antisense') into the DNA of the potato. This blocks the information to synthesise the enzyme.

Some virus-resistant transgenic plants that contain cloned viral coat proteins

Plant(s)	Virus that provided the coat protein gene
<i>Nicotiana benthamiana</i> , <i>N. clevelandii</i>	Plum pox virus
<i>N. benthamiana</i> , squash	Watermelon mosaic virus 2
<i>N. benthamiana</i> , squash	Zucchini yellow mosaic virus
Papaya, tobacco	Papaya ringspot virus
Potato	Potato leafroll virus
Potato	Potato virus Y
Potato, <i>Nicotiana debneyii</i>	Potato virus S
Potato, tobacco	Potato virus X
Rice	Rice stripe virus
Tobacco	Arabis mosaic virus
Tobacco	Soybean mosaic virus
Tobacco	Tobacco etch virus
Tobacco	Tobacco streak virus
Tobacco	Tomato spotted wilt virus
Tobacco, alfalfa, tomato	Alfalfa mosaic virus
Tobacco, cucumber	Cucumber mosaic virus
Tobacco, <i>N. benthamiana</i>	Tobacco rattle virus
Tobacco, tomato	Tobacco mosaic virus
Tomato	Tomato mosaic virus

Virus Resistance

Adapted from Fitchen and Beachy, *Annu. Rev. Microbiol.* 47:739–763, 1993.

Figure 18.7 Procedure for introducing cucumber mosaic virus coat protein cDNA into plant cells. RNA4, which encodes the coat protein, is fractionated from a viral RNA preparation and used as the template for the synthesis of double-stranded cDNA. Linkers are added to the cDNA preparation, and the cDNAs are cloned into an *E. coli* plasmid vector. A full-length cDNA clone is identified, excised from the *E. coli* vector, and subcloned into a Ti plasmid cloning vector between the 35S promoter from cauliflower mosaic virus (P_{35S}) and the transcription terminator from the gene for the small subunit of ribulose biphosphate carboxylase (*tRBC*). This cloning step creates two orientations for the RNA4 cDNA. In one case, the RNA that is transcribed is translated into coat protein (sense RNA), and in the other case, the transcribed RNA is complementary to the mRNA for the coat protein (antisense RNA).

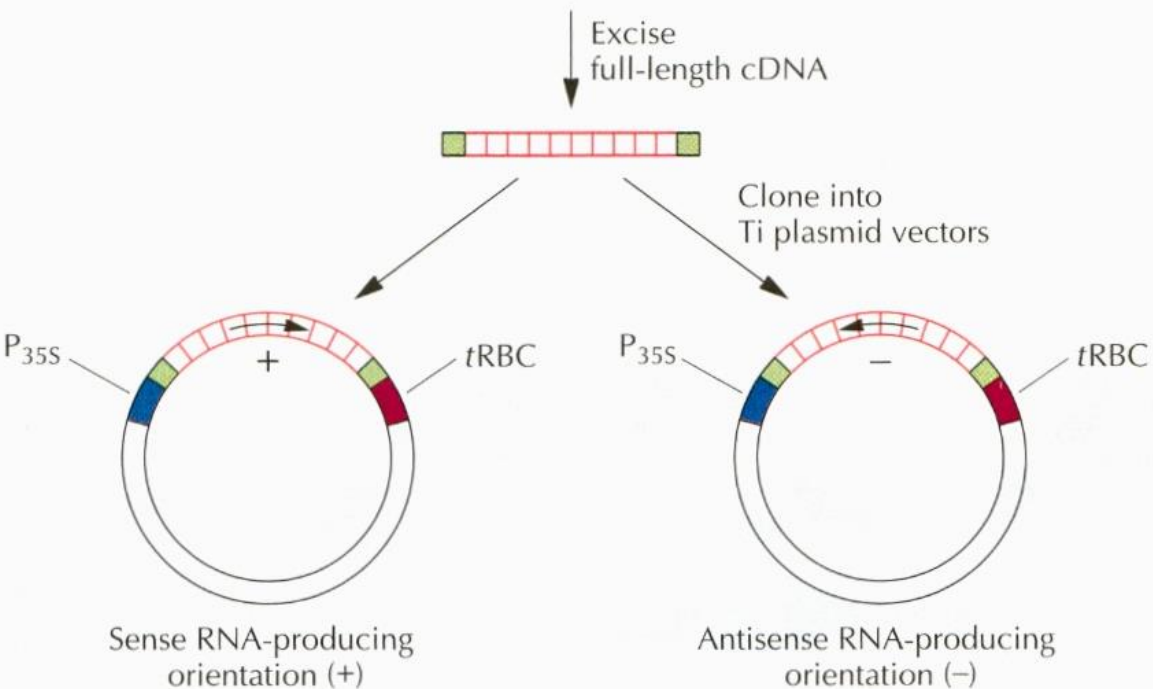
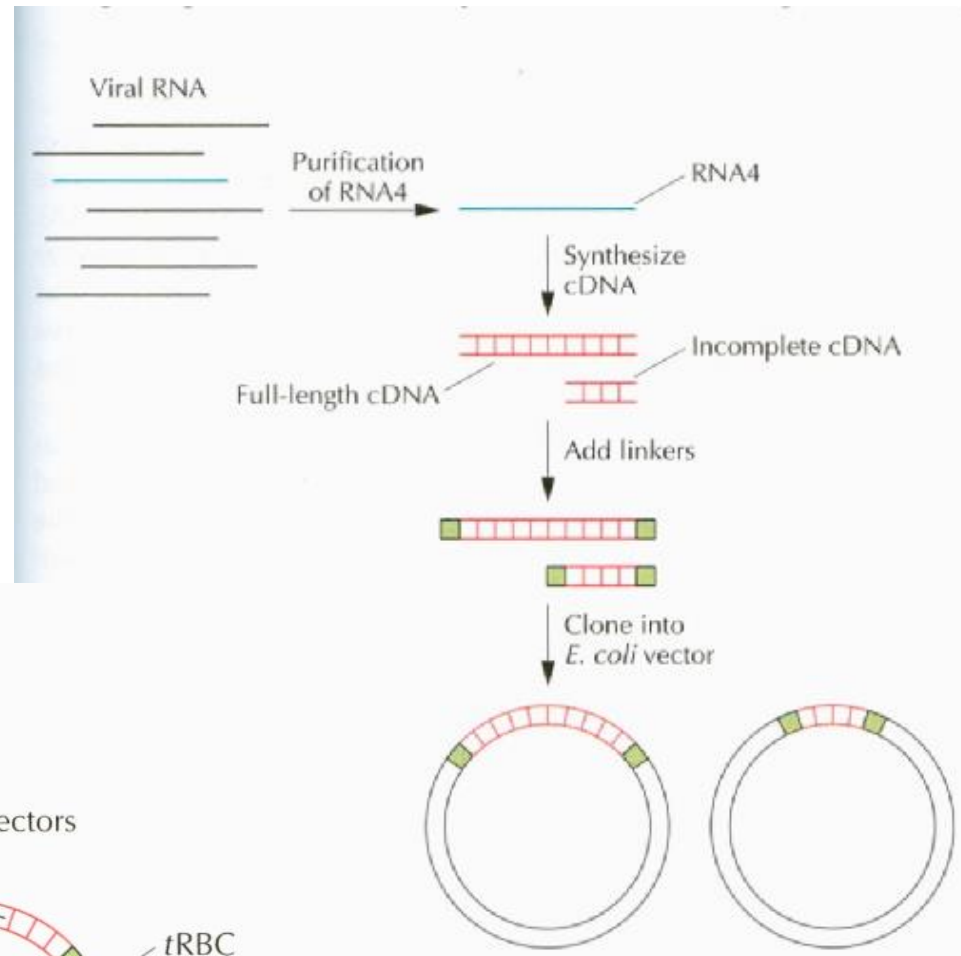

Virus Resistance

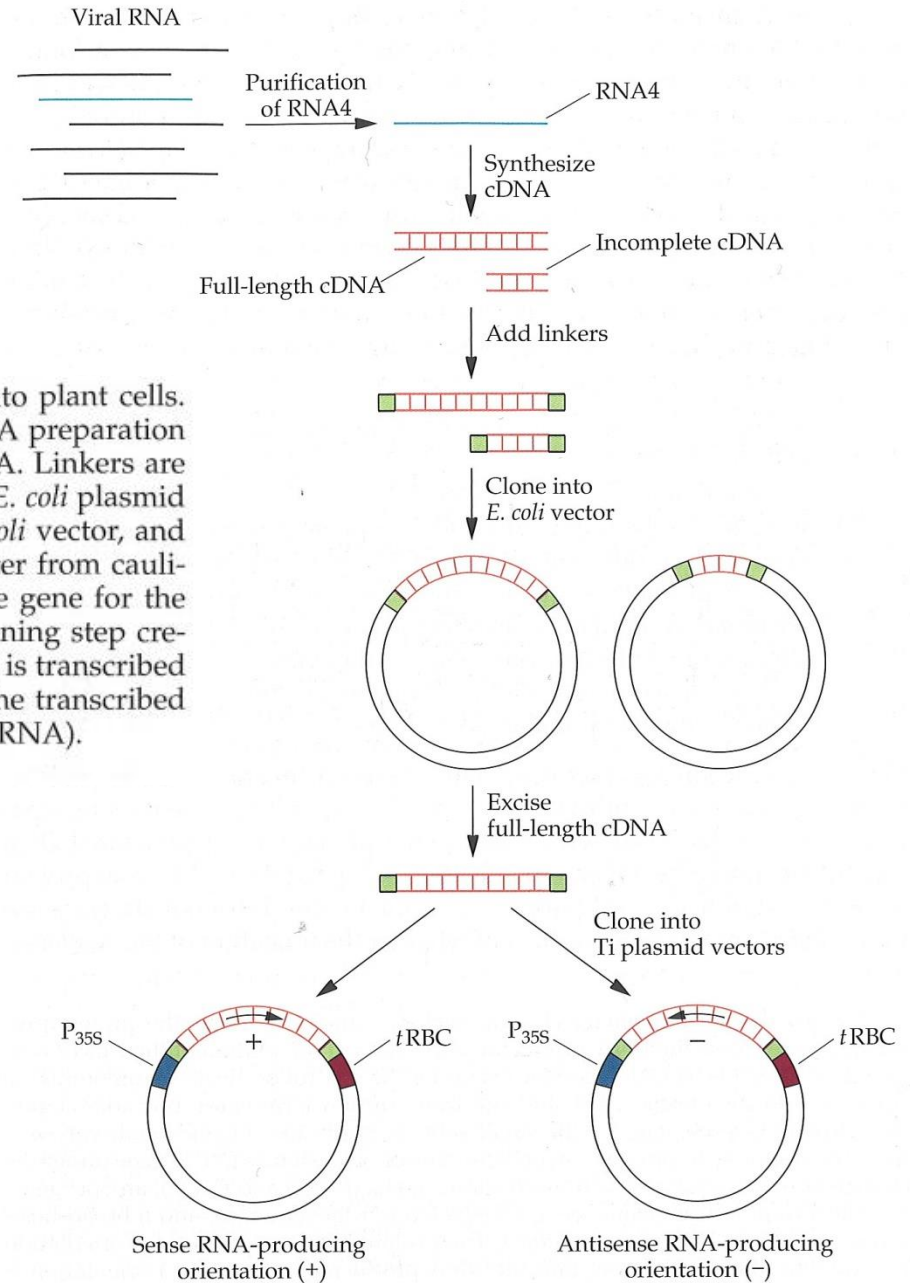
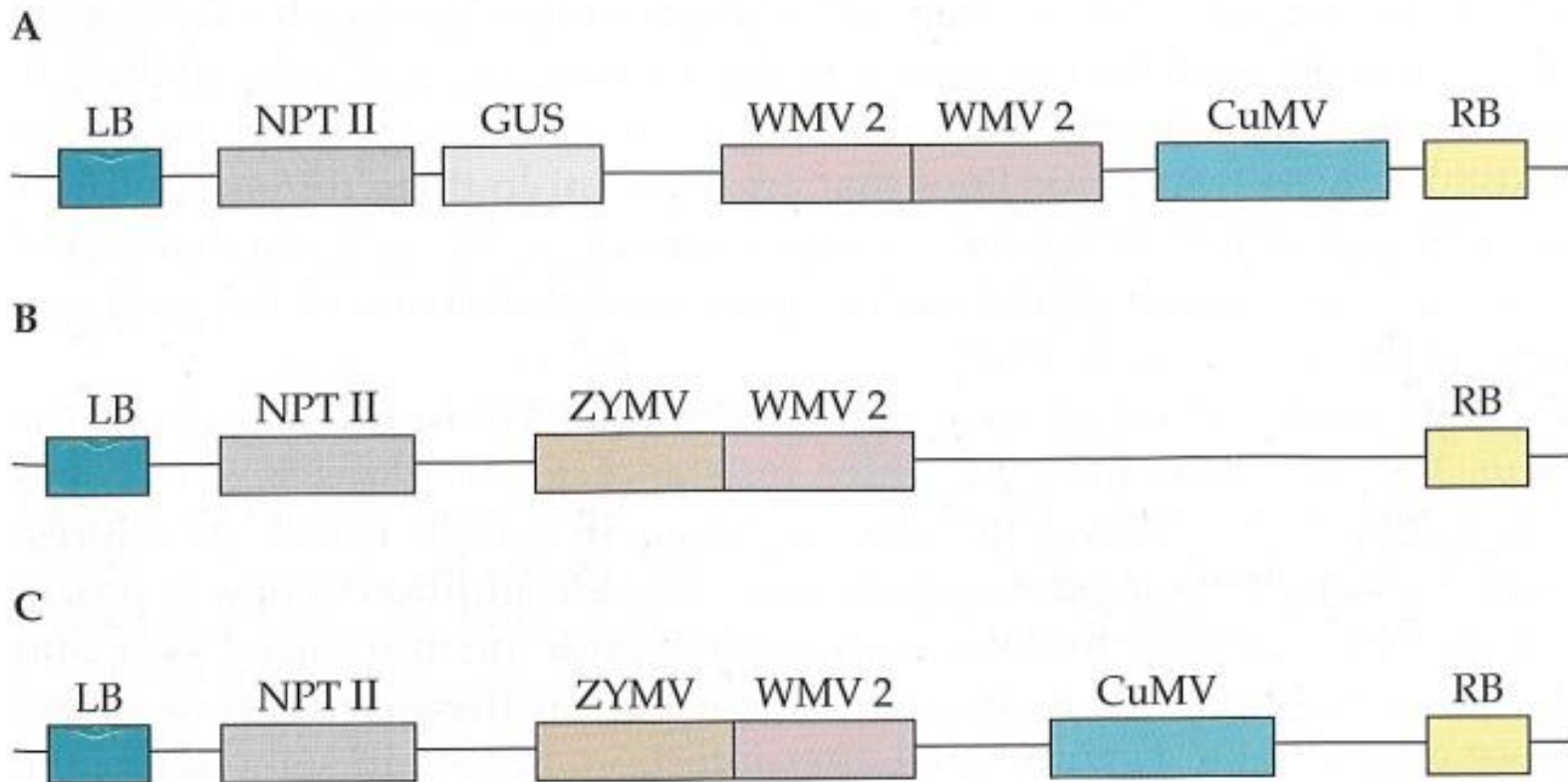
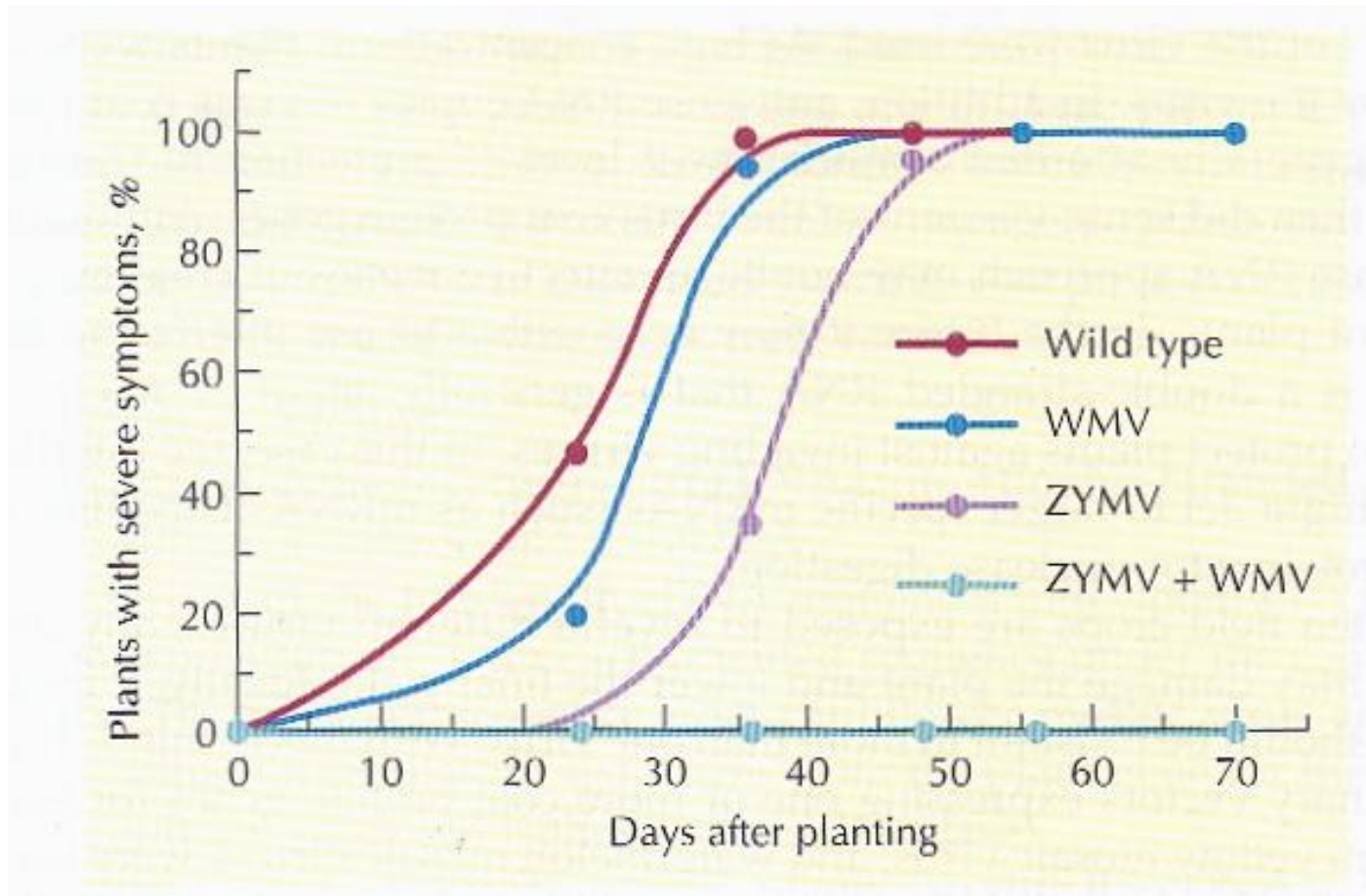

FIGURE 19.11 Procedure for introducing CuMV coat protein cDNA into plant cells. RNA4, which encodes the coat protein, is isolated from a viral RNA preparation and used as the template for the synthesis of double-stranded cDNA. Linkers are added to the cDNA preparation, and the cDNAs are cloned into an *E. coli* plasmid vector. A full-length cDNA clone is identified, excised from the *E. coli* vector, and subcloned into a Ti plasmid cloning vector between the 35S promoter from cauliflower mosaic virus (P_{35S}) and the transcription terminator from the gene for the small subunit of ribulose biphosphate carboxylase (*tRBC*). This cloning step creates two orientations for the RNA4 cDNA. In one case, the RNA that is transcribed is translated into coat protein (sense RNA), and in the other case, the transcribed RNA is complementary to the mRNA for the coat protein (antisense RNA).

FIGURE 19.13 (A) A T-DNA construct with a neomycin phosphotransferase (NPT II) gene as a selectable marker, a β -glucuronidase (GUS) gene as a reporter gene, two copies of the coat protein gene from watermelon mosaic virus 2 (WMV 2), and the coat protein gene from CuMV. The left and right borders of the T-DNA are indicated by LB and RB, respectively. (B) Similar to panel A without CuMV and GUS, with one copy of WMV 2, and with the coat protein gene from zucchini yellow mosaic virus (ZYMV). (C) Same as panel B with the addition of CuMV. All of the genes in these constructs include both promoters and transcription terminator regions.





Disease frequency in transgenic and nontransformed (wild-type) yellow crookneck squash in the field. Aphids were used to transmit a mixture of zucchini yellow mosaic virus (ZYMV) and watermelon mosaic virus 2 (WMV) to the squash plants. Adapted from Fuchs and Gonsalves, *Bio/Technology* 13:1466–1473, 1995.

10.12.15

Dry Resistance

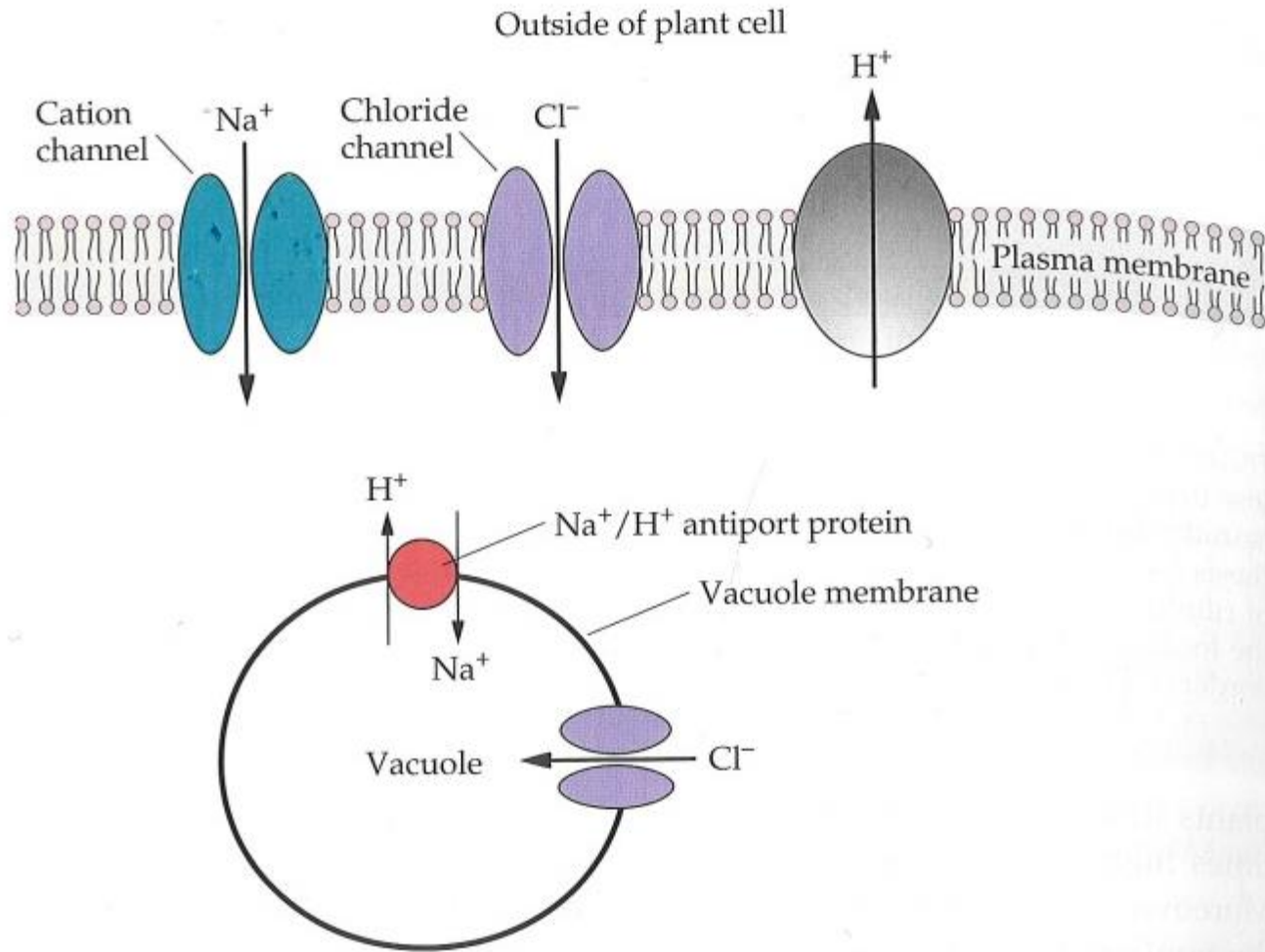
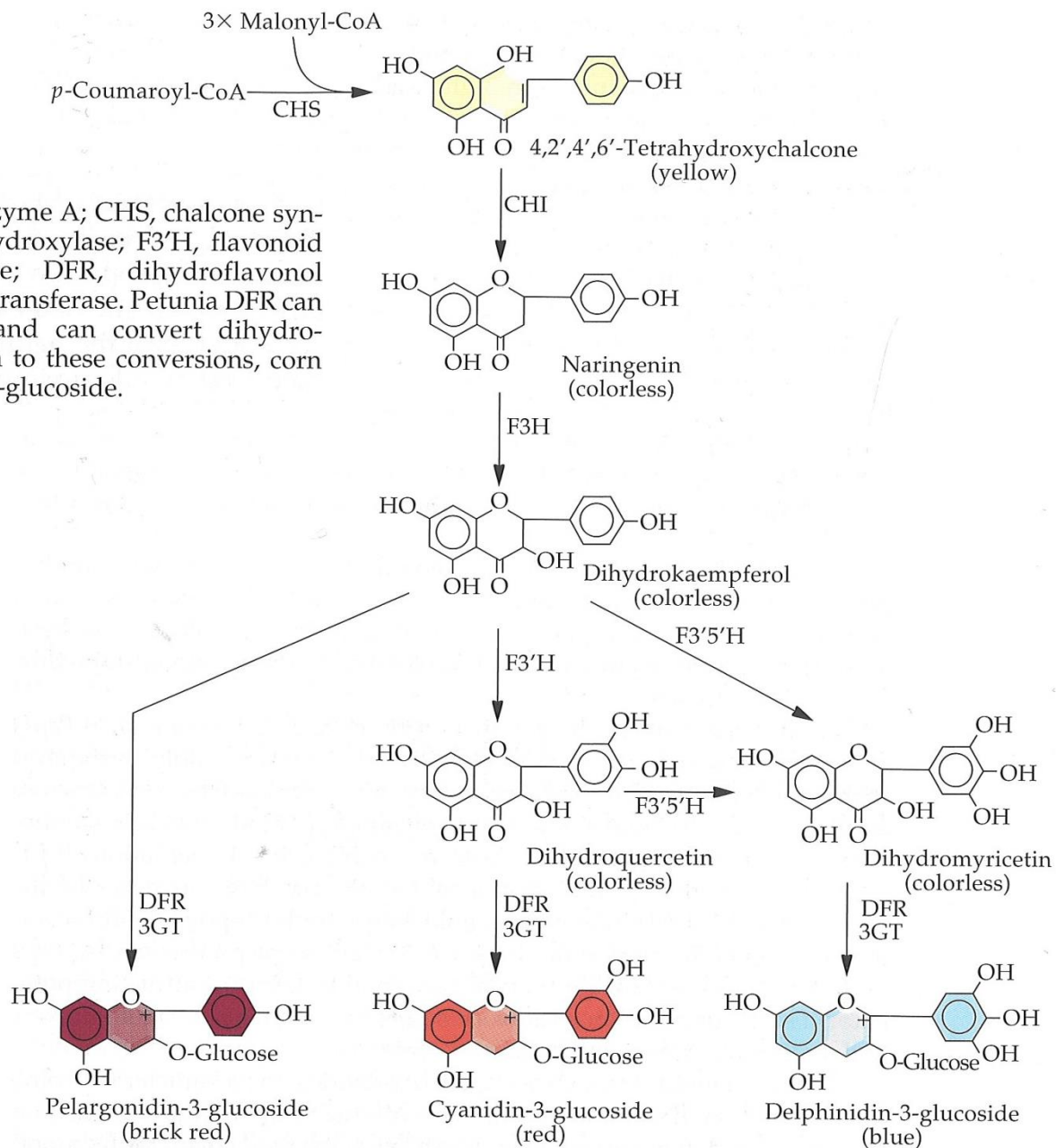
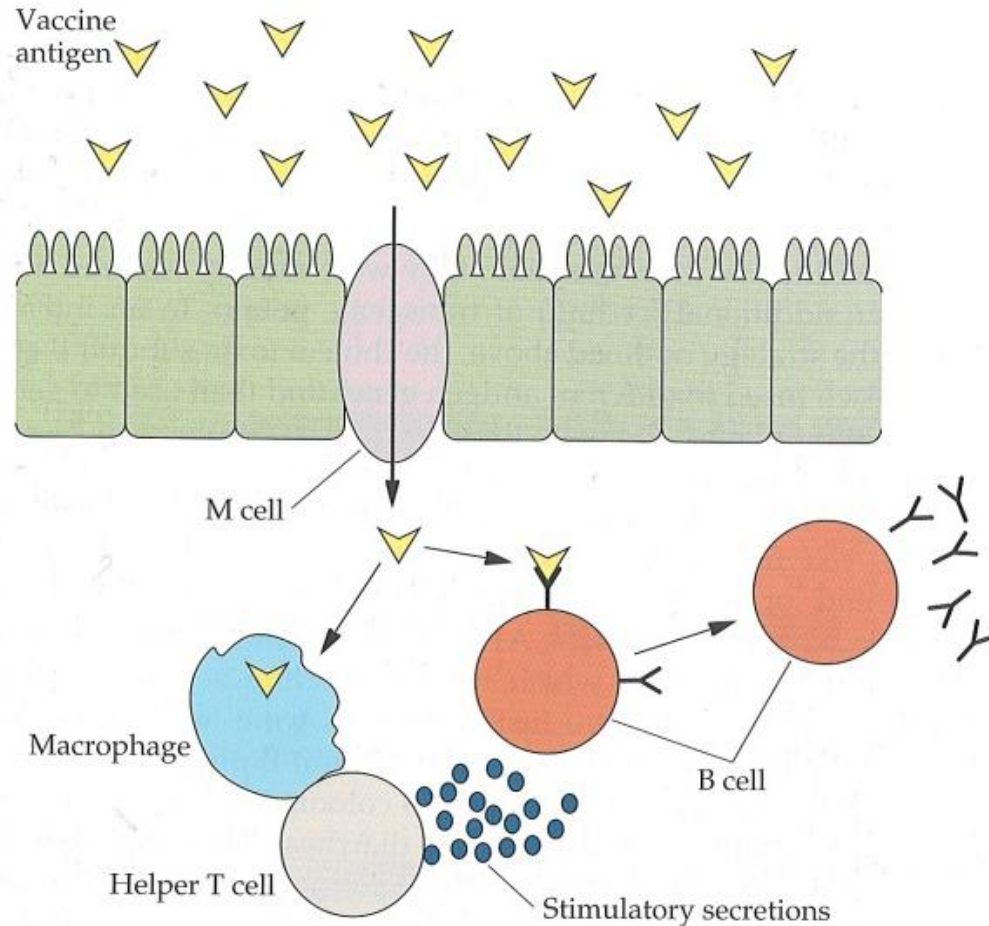

FIGURE 19.33 Schematic representation of ion transport in the plant *A. thaliana* showing the Na^+ ions being sequestered in the large vacuole.

Plant Colour

FIGURE 20.18 Biosynthesis of anthocyanins. CoA, coenzyme A; CHS, chalcone synthase; CHI, chalcone isomerase; F3H, flavonone 3-hydroxylase; F3'H, flavonoid 3'-hydroxyase; F3'5'H, flavonoid 3',5'-hydroxylase; DFR, dihydroflavonol 4-reductase; 3GT, UDP-glucose:flavonoid 3-O-glucosyltransferase. *Petunia* DFR can convert dihydroquercetin to cyanidin-3-glucoside and can convert dihydromyricetin to blue delphinidin-3-glucoside. In addition to these conversions, corn DFR can convert dihydrokaempferol to pelargonidin-3-glucoside.





vaccination banana??!



FIGURE 20.22 Schematic representation of how an edible vaccine generates an immune response against an antigen from an infectious agent. The ingested antigen, which is expressed as part of a plant, binds to and is taken up by M cells present in the lining of the intestine and is then passed to other cells in the immune system, including macrophages and B cells. The macrophages display portions of the antigen to the helper T cells, which in turn respond by secreting small molecules that activate B cells to synthesize and release antibodies that can neutralize the antigen.

Vaccines and plants used

Vaccination against	Plants used	Directly edible
Cholera	Potato, Tomato, Tobacco	Yes
Norwalk Virus	Potato, Tomato, Tobacco	Yes
Papilloma Virus (HPV)	Potato, Tomato, Tobacco	Yes
Rabies	Spinach	Yes
Hepatitis B (HBV)	Potato, Lupin	Yes
E. coli Enterotoxin (ETEC)	Potato, Tobacco, Mais	Yes
Transmissible Gastroenteritis Virus (a pig disease)	Mais	Yes
Non-Hodgkins Lymphoma	Tobacco (Tobacco Mosaic Virus)	No
Influenza (Rhino RX)	Tobacco	No



The most damaging micronutrient deficiencies in the world are the consequence of low dietary intake of iron, vitamin A, iodine and zinc. **Vitamin A deficiency (VAD)** is prevalent among the poor whose diets are based mainly on rice or other carbohydrate-rich, micronutrient-poor calorie sources. **Rice does not contain any β -carotene (provitamin A)**, which their body could then convert into vitamin A. Dependence on rice as the predominant food source, therefore, necessarily leads to VAD, most severely affecting small children and pregnant women. In **2012** the **World Health Organization** reported that about **250 million preschool children are affected by VAD**, and that providing those children with vitamin A could prevent about a third of all under-five deaths, which amounts to up to 2.7 million children that could be saved from dying unnecessarily.

VAD compromises the immune systems of approximately 40 percent of children under five in the developing world, greatly increasing the severeness of common childhood infections, often leading to deadly outcomes. VAD is most severe in **Southeast Asia and Africa**. For the 400 million rice-consuming poor, the medical consequences are fatal: impaired vision—, in extreme cases irreversible blindness; impaired epithelial integrity, exposing the affected individuals to infections; reduced immune response; impaired haemopoiesis (and hence reduced capacity to transport oxygen in the blood) and skeletal growth; among other debilitating afflictions.

Golden Rice

The precursor molecule for carotenoid biosynthesis is geranylgeranyl diphosphate (GGDP). Horizontal bars delimit the steps of the carotenoid biosynthetic pathway that were overcome using the two transgenes phytoene synthase (PSY) and the multifunctional bacterial carotene desaturase (CRTI), rather than the two plant desaturases PDS and ZDS.

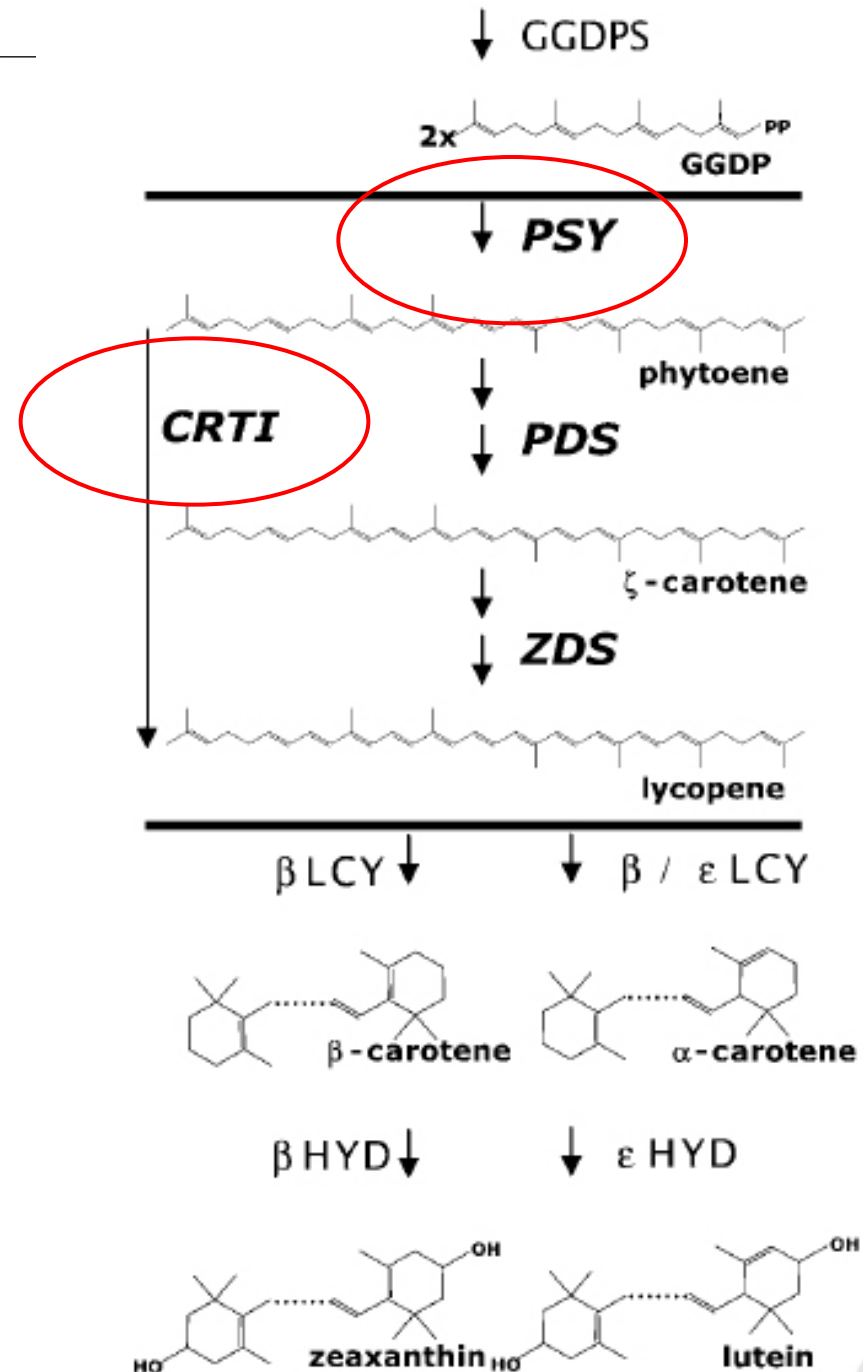

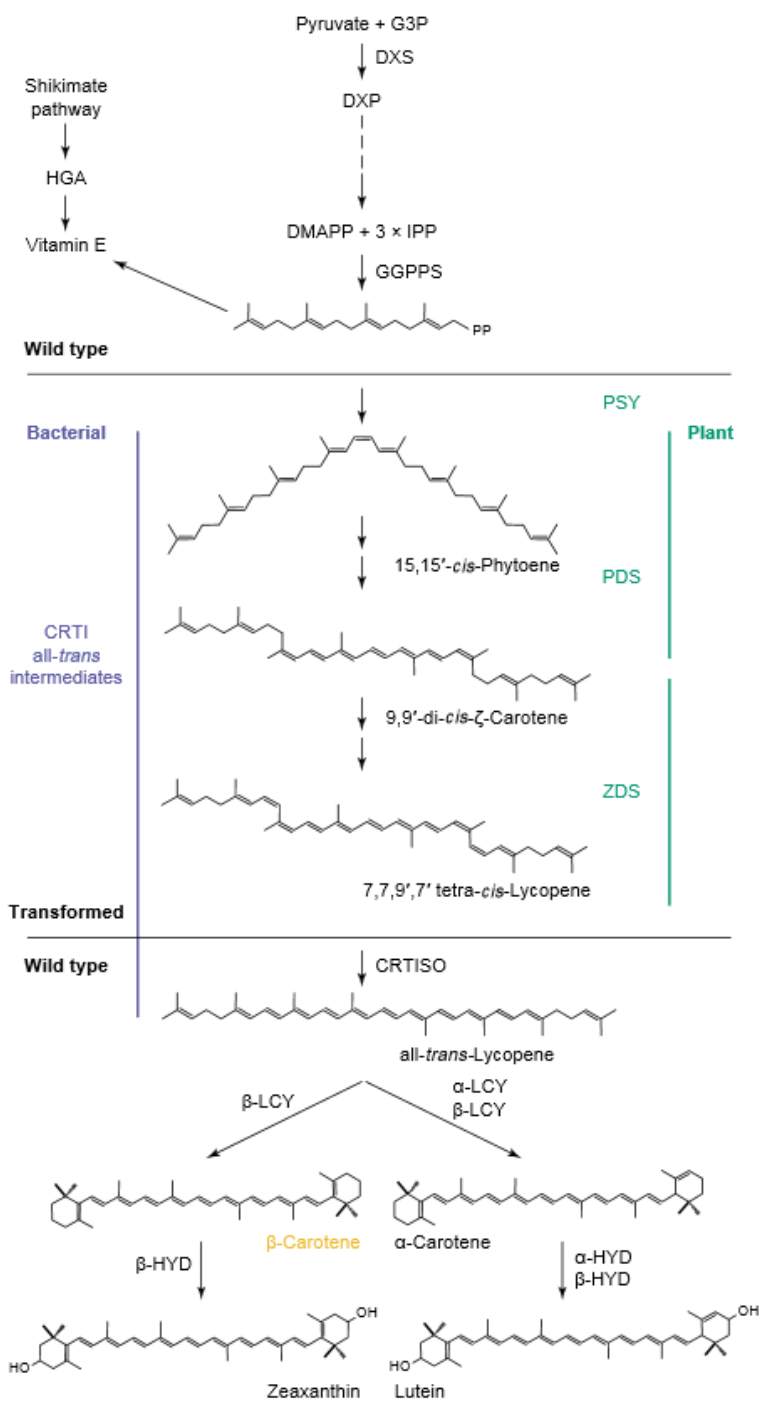
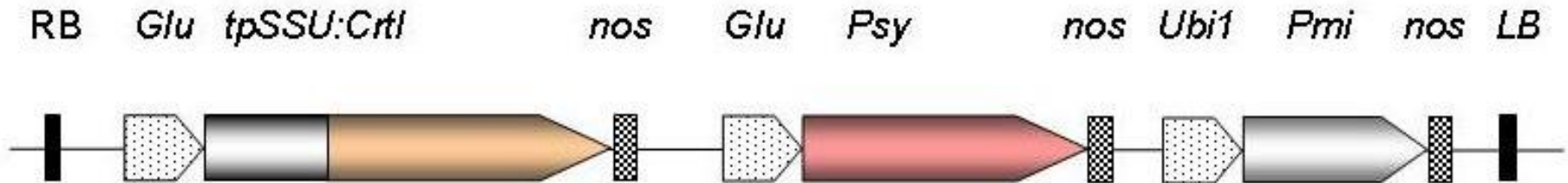

Figure 2.

Essentials of carotenoid biosynthesis related to Golden Rice (GR). Wild-type rice has the biosynthetic capacity to produce geranylgeranyl-diphosphate (GGPP), which stems (when synthesized in amyloplasts) from an initial decarboxylation of pyruvate and condensation with glyceraldehyde-3-phosphate catalyzed by 1-deoxy-D-xylulose-5 phosphate synthase (DXS). A series of reactions [34] leads to the formation of isopentenyl-diphosphate (IPP) and its isomer, dimethylallyl-diphosphate (DMAPP), the building blocks of isoprenoids. These are used to form GGPP by the enzyme GGPP synthase (GGPPS). GGPPS enters into a variety of prenylation and cyclization reactions, among which only vitamin E biosynthesis is considered here, starting with its condensation with a non-prenyl acceptor, homogentisic acid (HGA), stemming from the shikimate pathway. To proceed towards b-carotene formation, the plant enzymes phytoene synthase (PSY), phytoene-desaturase (PDS), z-carotene-desaturase (ZDS) and carotene cis-trans-isomerase (CRTISO) need to be supplemented. CRTISO is required to convert the specific cis-carotene intermediates [35] into the final all-trans form of lycopene that is cyclized. The bacterial desaturase CRTI, expressed along with a plant PSY, substitutes for the three plant enzymes by performing the complete desaturation sequence with all-trans intermediates. Beyond the sequence of transformed genes, lycopene cyclases (LCY) expressed in wild-type rice are sufficiently active to produce a- and b-carotene as well as hydroxylases (HYD), which lead to the respective derived hydroxylated xanthophylls. The intrinsic activity of CRTISO is required in experimental GR versions expressing the plant desaturases.

Golden Rice



Gene construct used to generate *Golden Rice*. RB, T-DNA right border sequence; Glu, rice endosperm-specific glutelin promoter; tpSSU, pea ribulose bis-phosphate carboxylase small subunit transit peptide for chloroplast localisation; nos, nopaline synthase terminator; Psy, phytoene synthase gene from *Narcissus pseudonarcissus* (GR1) or *Zea mays* (GR2); Ubi1, maize polyubiquitin promoter; Pmi, phosphomannose isomerase gene from *E. coli* for positive selection (GR2); LB, T-DNA left border sequence.



The image clearly shows the progress made since the proof-of-concept stage of *Golden Rice*. The new generation, also known as GR2 contains β -carotene levels that will allow to provide an adequate amount of pro- vitamin A in normal children's diets in SE Asia.

FIGURE 18.21 Schematic representation of a plant in hydroponic culture secreting proteins and small molecules (red arrows) into the medium. The arrows at the inlet and outlet ports indicate the direction of flow of added nutrient solutions. The proteins secreted by the roots are concentrated and harvested from the hydroponic medium and then purified.

