

Hauptplatz großer, breiter Platz
 (Bestand)

Floriani-Platz langer, schmaler Platz
 (Bestand)

3. Platz großer, breiter Platz

wird aufgespannt von
Areal Klosterforum und
Bebauungsgebiet



Legende

bk1/bk2... Baukörperanz.
 1g/2g/... Geschoßanzahl
 ug Untergeschoß
 eg Erdgeschoß
 og Obergeschoß

- Fahrweg
- Fussweg/Platz
- Grünflächen öffentlich
- Grünflächen privat
- ruhender Verkehr
- Spielplatz

Bebauungs- dichte

Funktionen:
 Wohnen allgemein
 1000m² Bank
 750m² öffentl. Einrichtungen
 150m² mobiler Hilfsdienst

Wohnen allgem. 0,7
 BBD gesamt 1,1

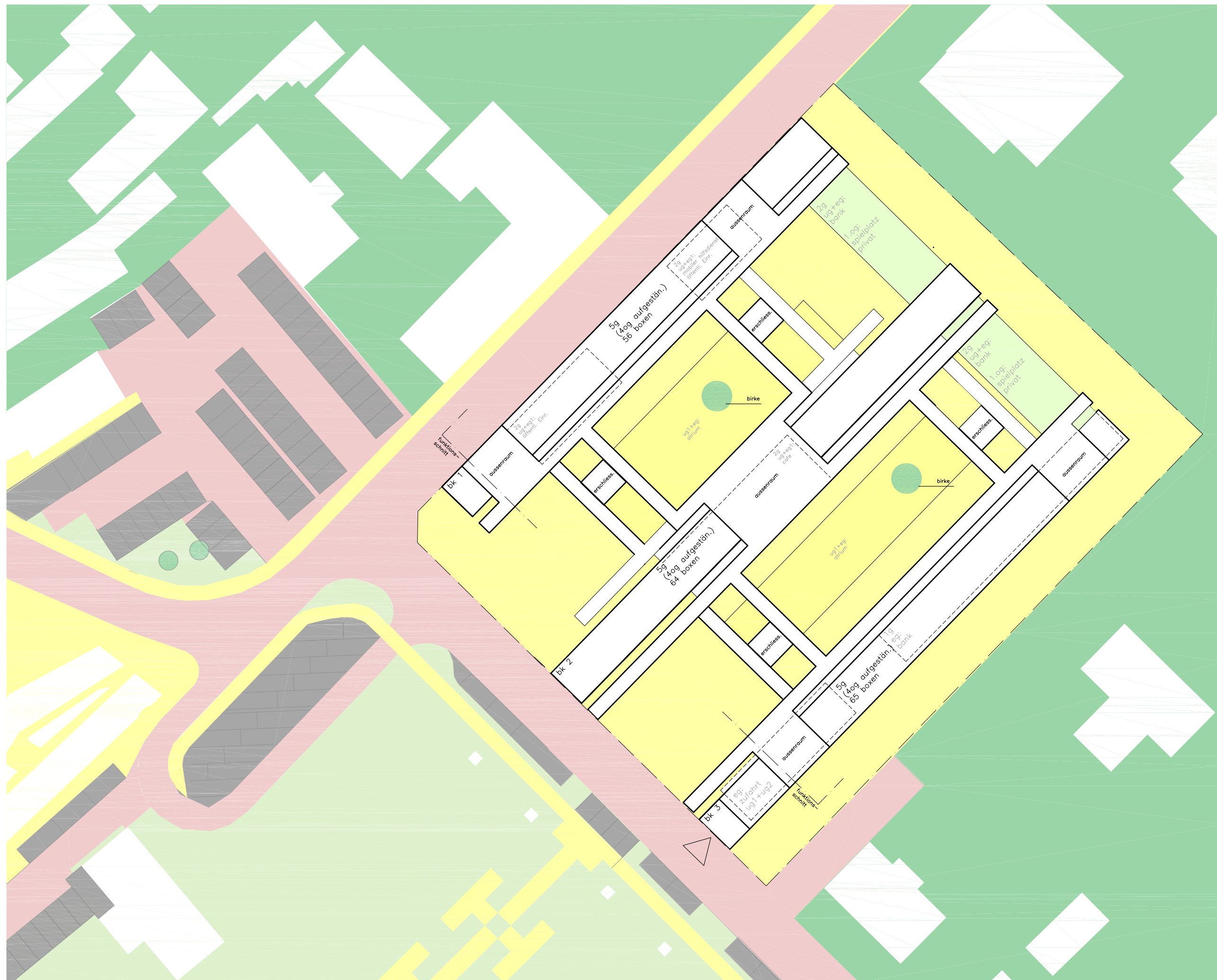
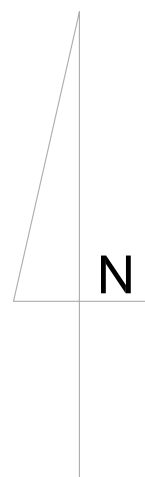

DATUM | 21.03
UHRZEIT | 12:00

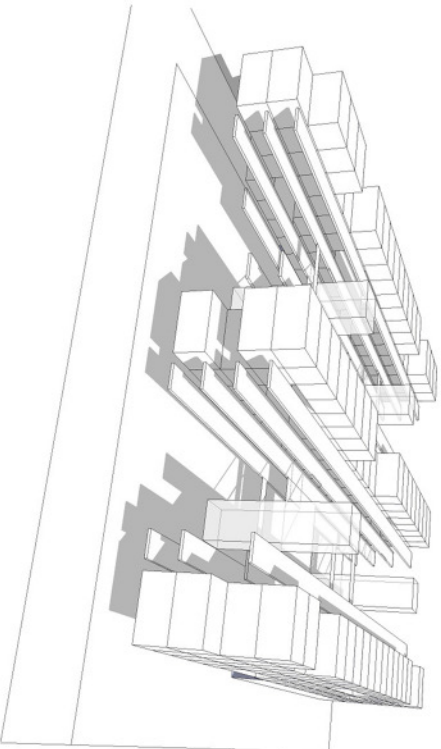

DATUM | 21.06
UHRZEIT | 12:00

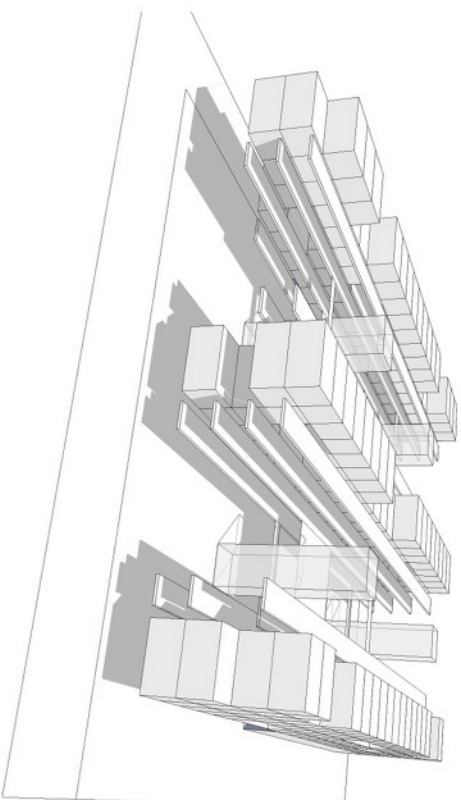

DATUM | 21.09
UHRZEIT | 12:00

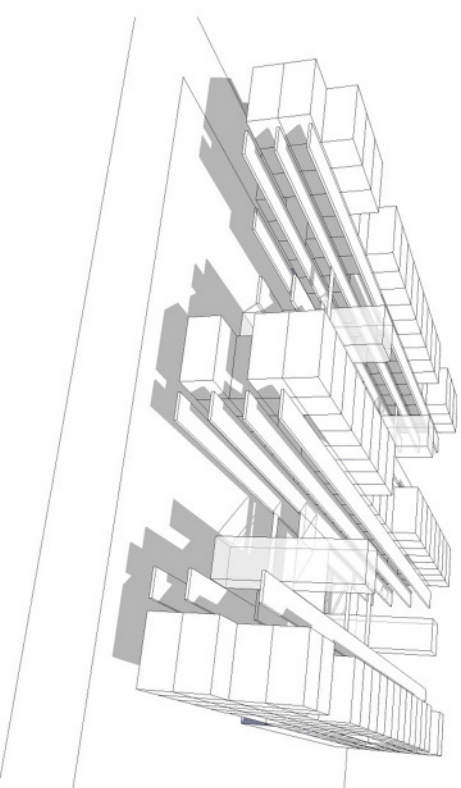

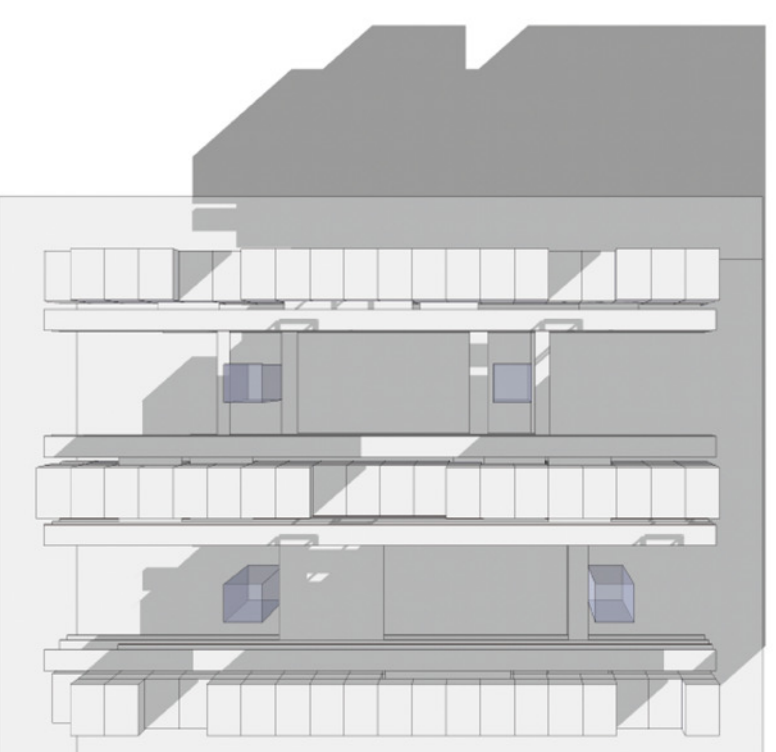
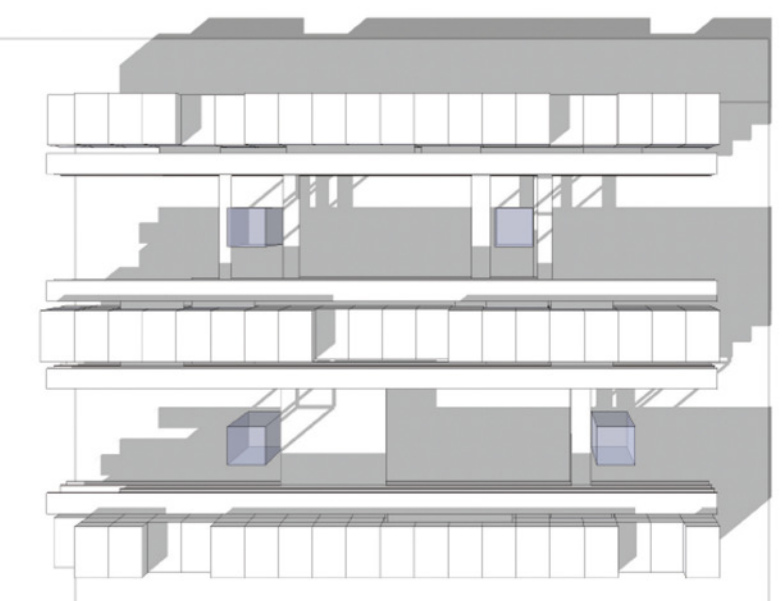
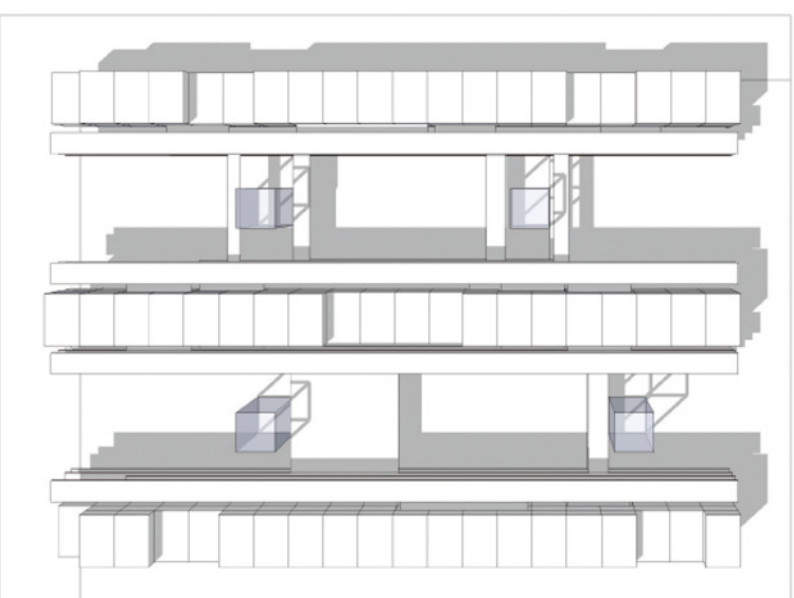
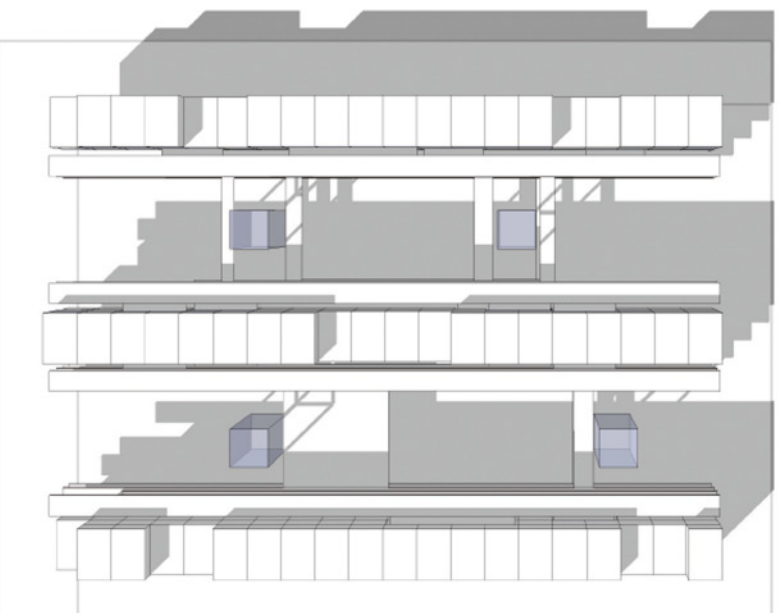
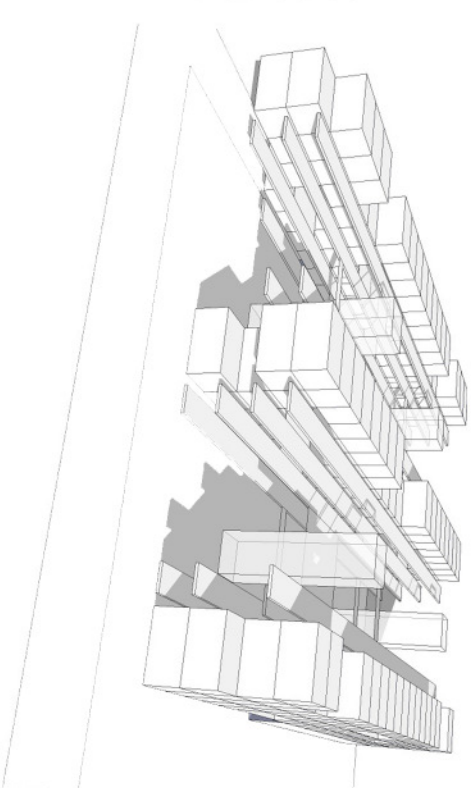

DATUM | 21.12
UHRZEIT | 12:00

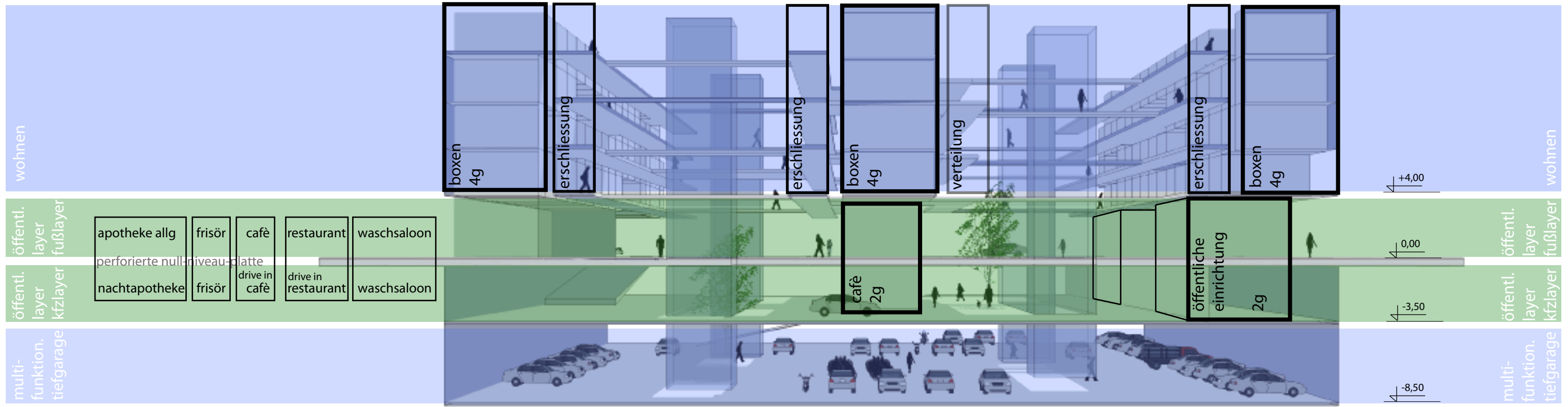

Schnitt - Funktionen

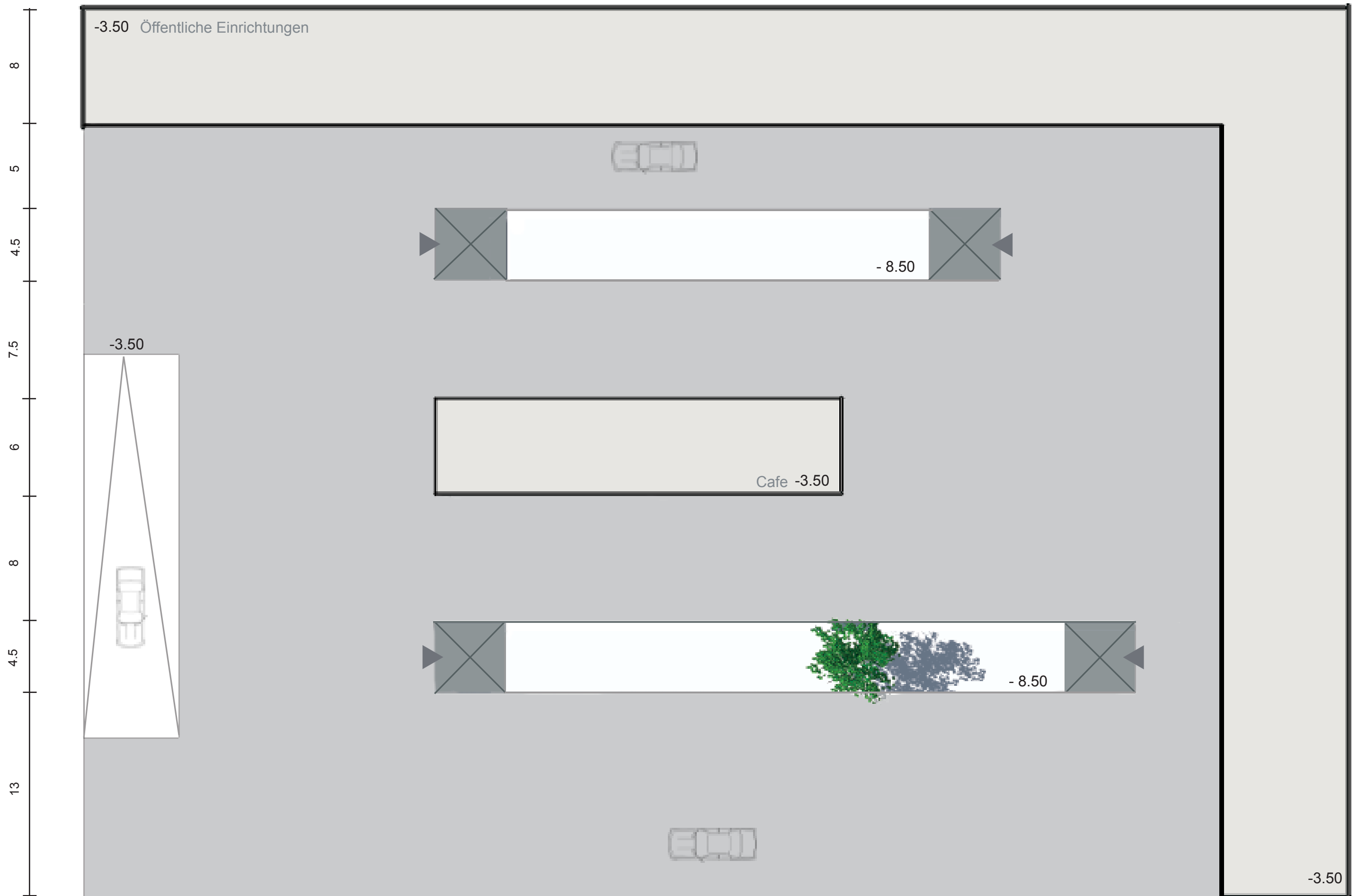



-  Erschließung vertikal
-  Öffentliche Einrichtungen

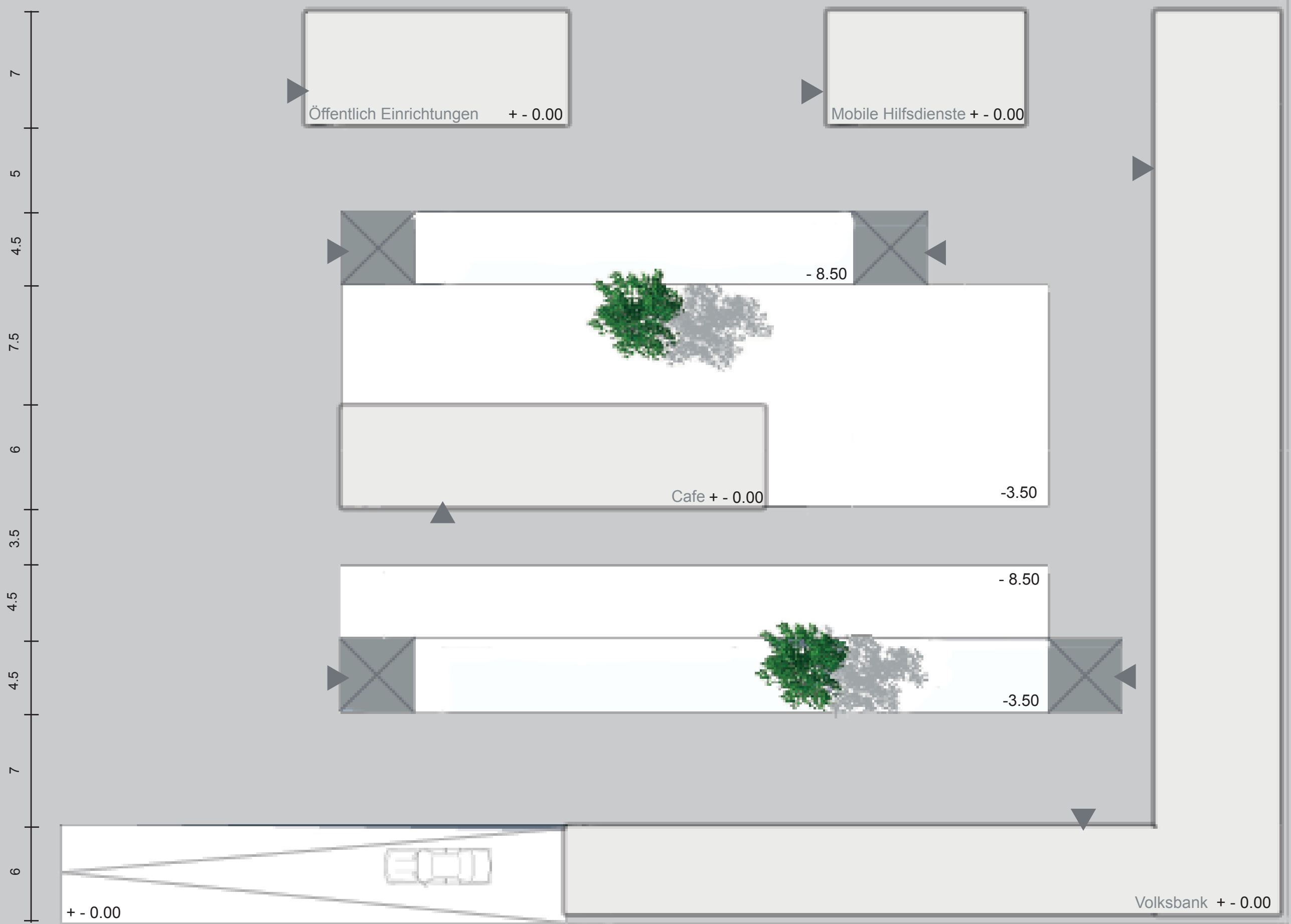

-  Erschließung vertikal
-  Öffentliche Einrichtungen

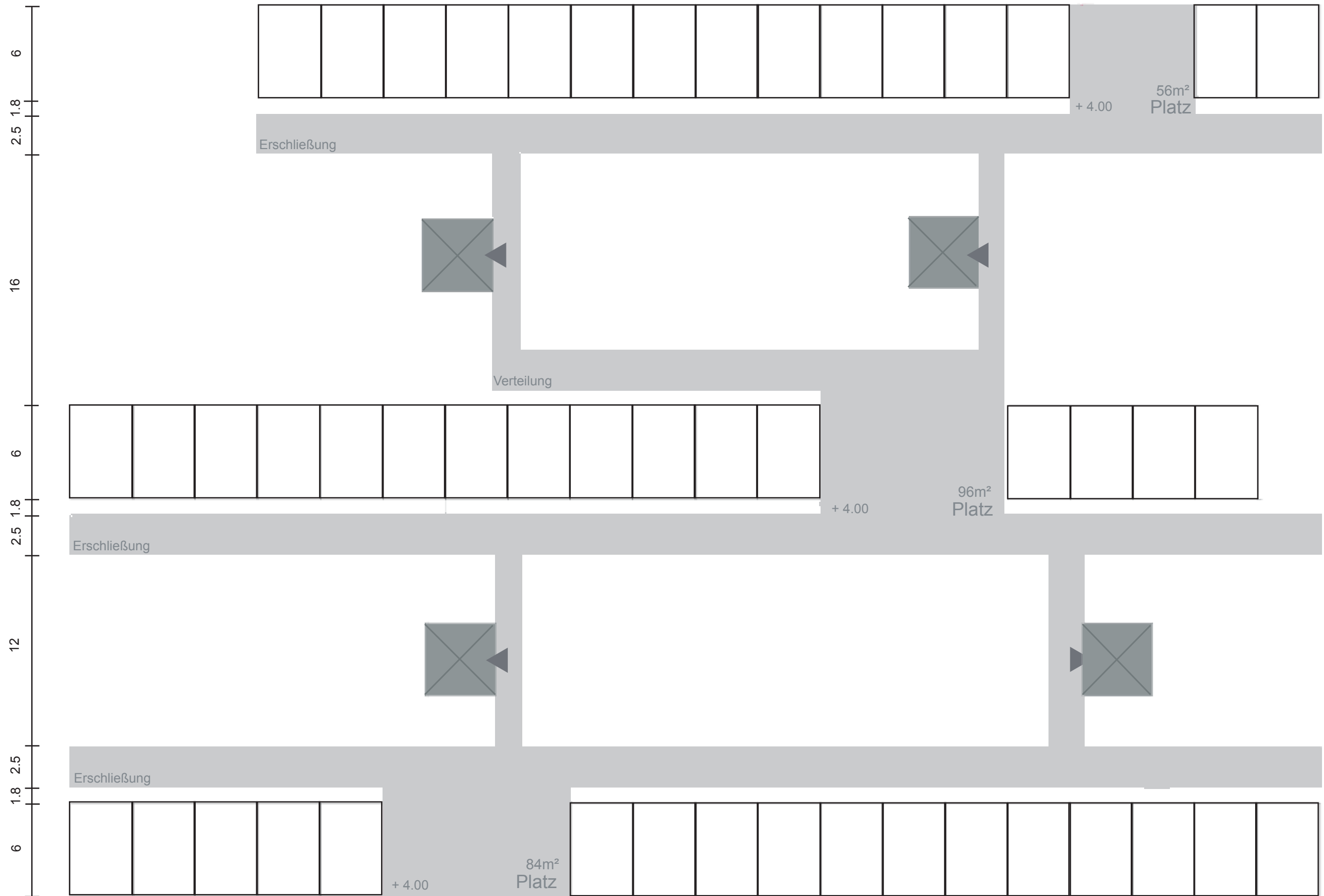

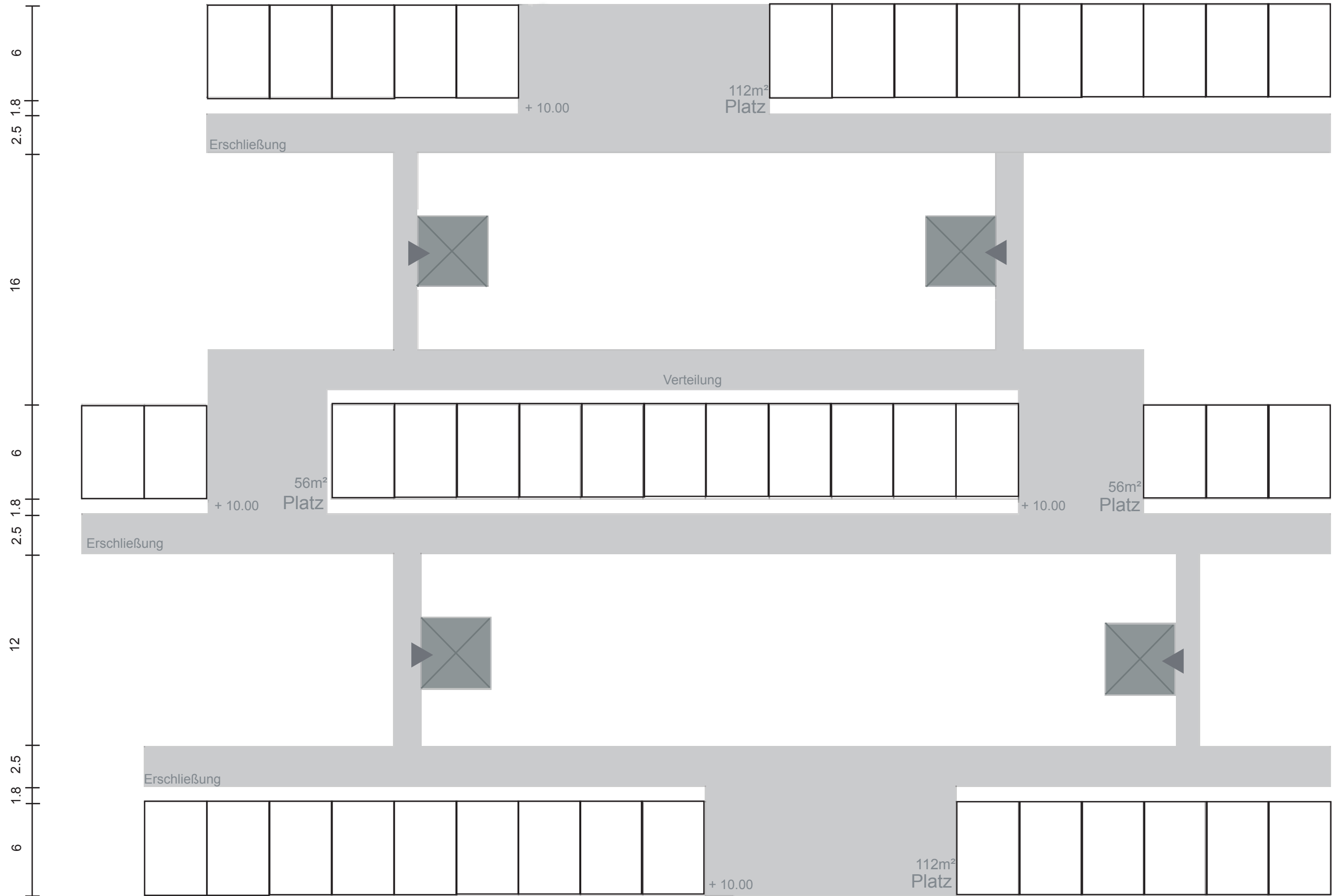

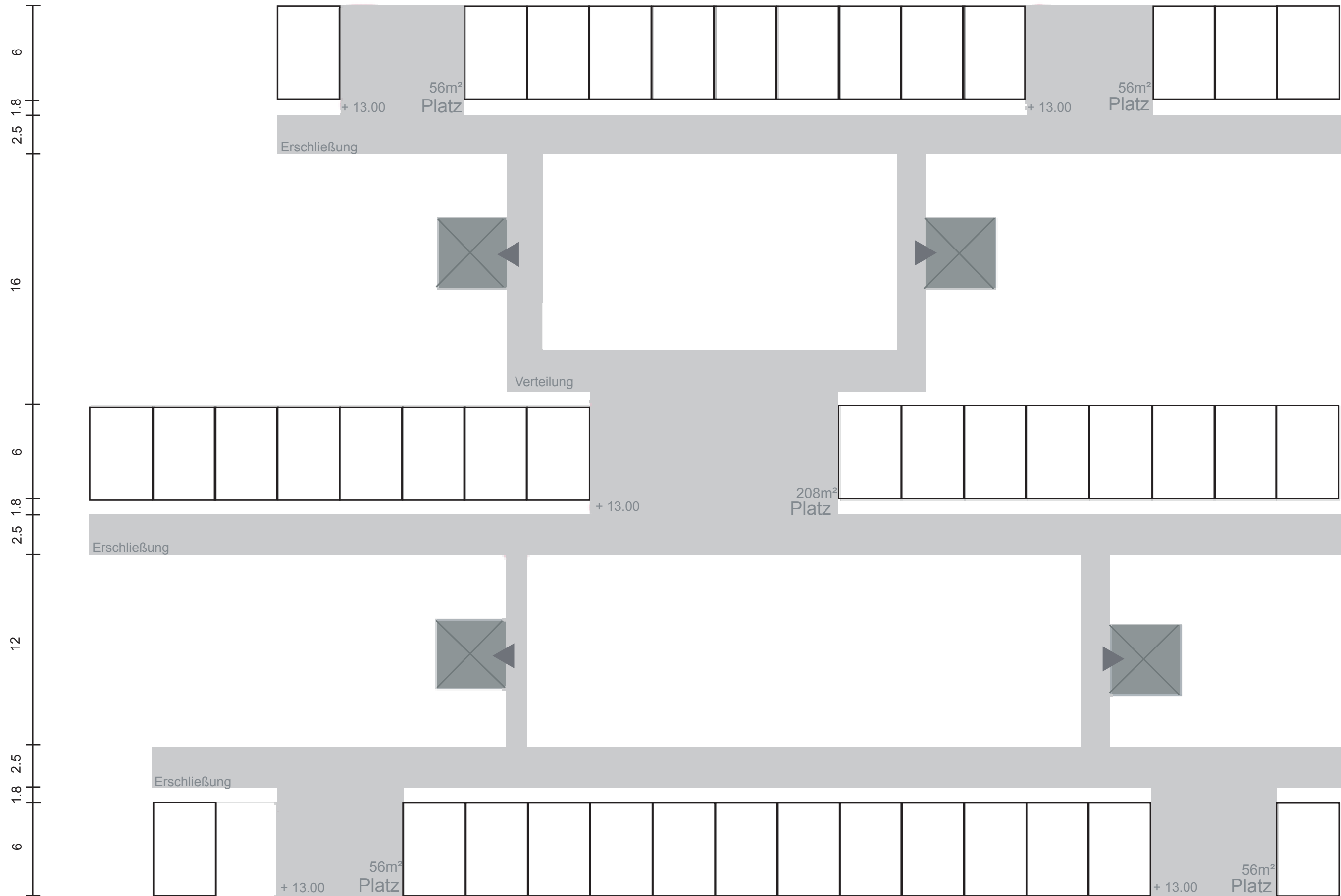

Grundriss-Varianten

boxen: 1

boxen: 2

boxen: 3

boxen: 4

variante 1

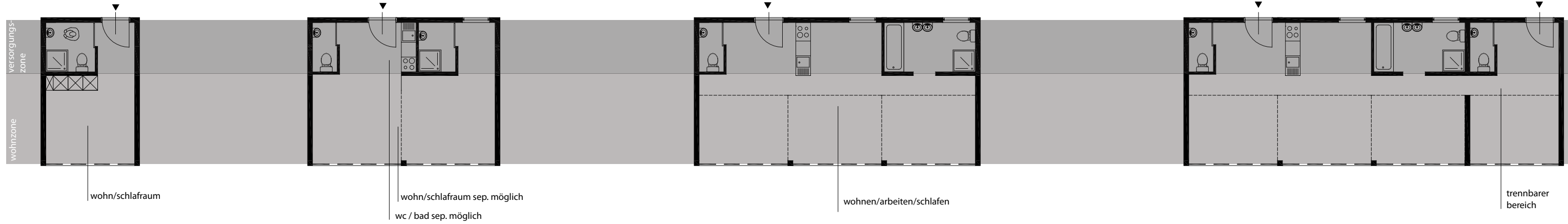

variante 2

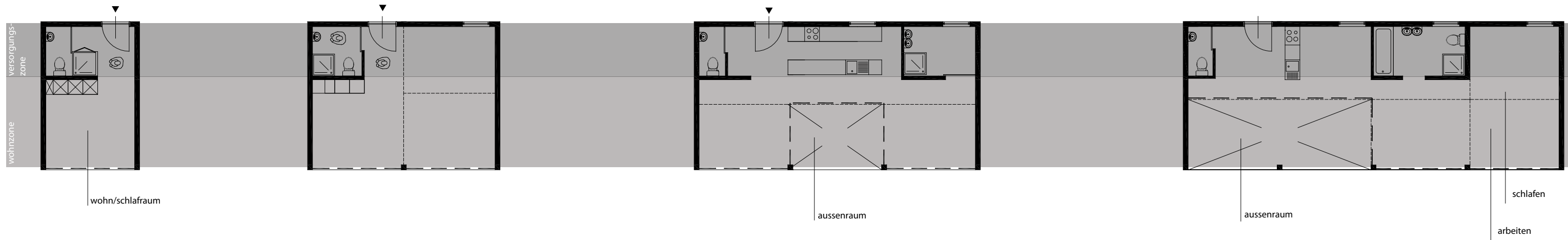

variante 3



basisbox 24m² | 6m x 4m

--- glasfassade

Varianten - Zonierung

basisbox 24m² (6m x 4m)

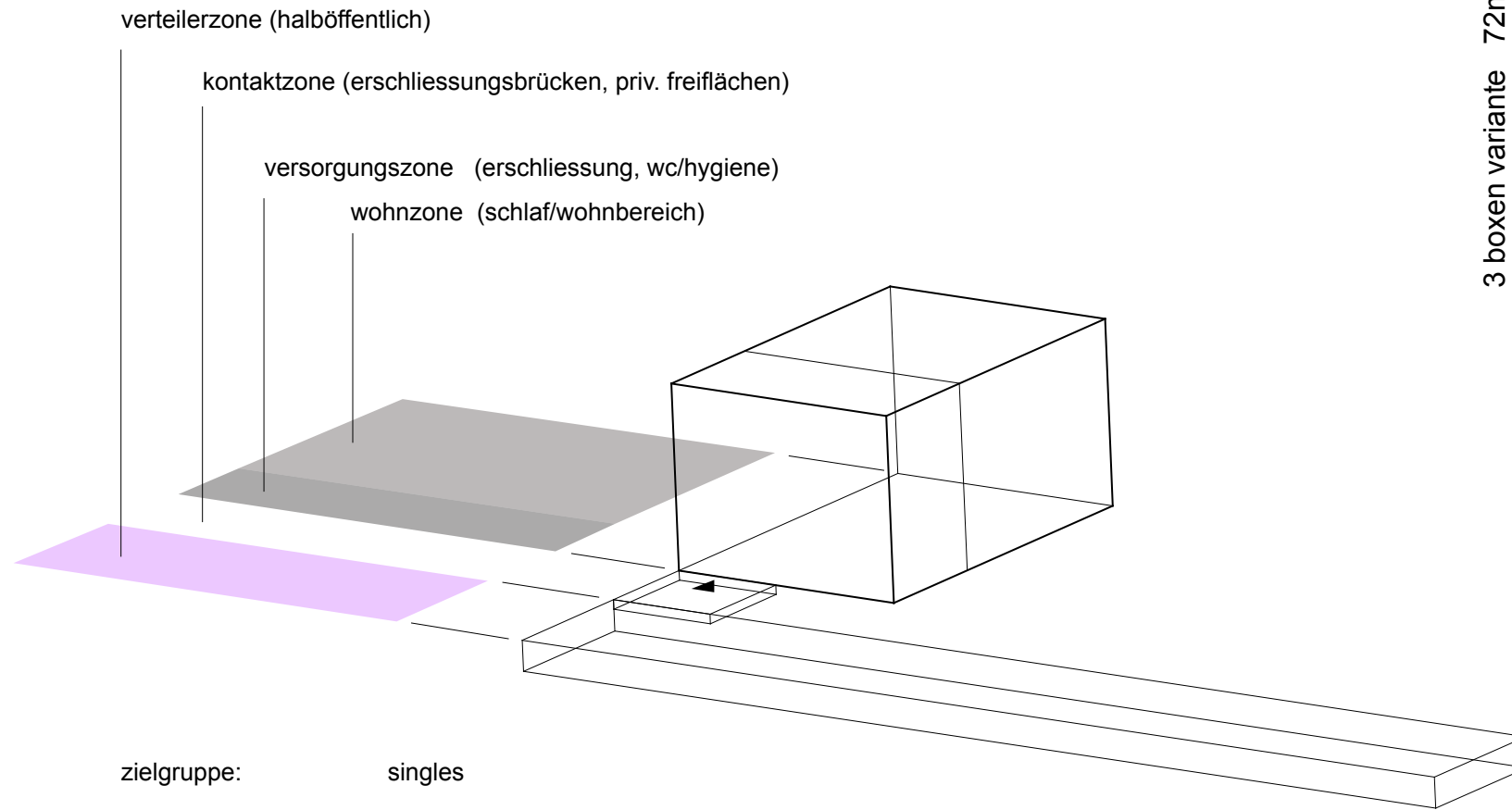

3 boxen variante 72m²

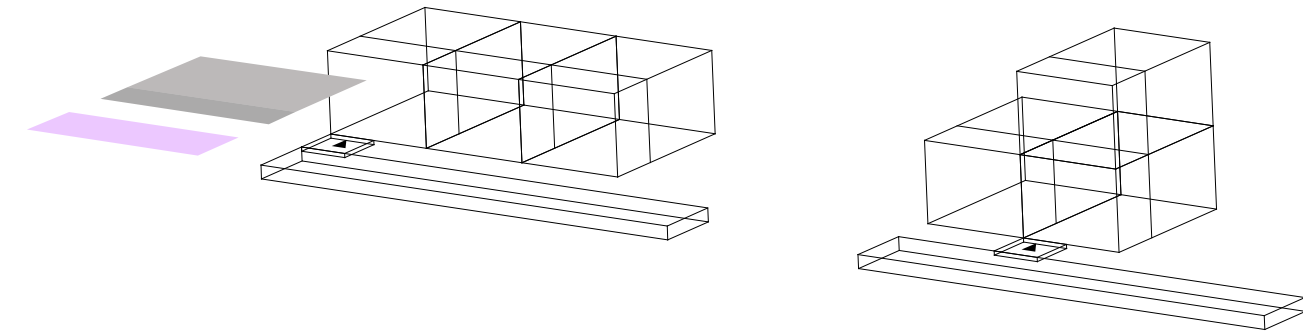

- wohnzone: wohn- und schlafbereich, mehr zi variante, gallerie, maisonette, rückzugsbereich
- versorgungszone: erschliessung, wc, bad sep. möglich
- kontaktzone: erschliessungsbrücke, vergrößerte freiflächen
- zielgruppe: eltern + kinder, abtrennbare bereiche, sep. erschliessbar, generationen wohnen paare mit arbeitsbereiche

2 boxen variante 48m²

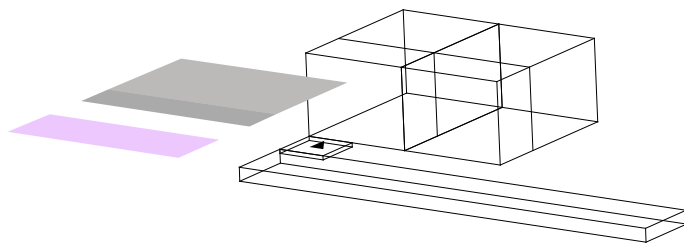

- wohnzone: wohn- und schlafbereich sep. möglich
- versorgungszone: erschliessung, wc, bad sep. möglich
- kontaktzone: erschliessungsbrücke, vergrößerte freiflächen
- zielgruppe: singles, junge paare, singles mit arbeitsbereich senioren

4 boxen variante 96m²

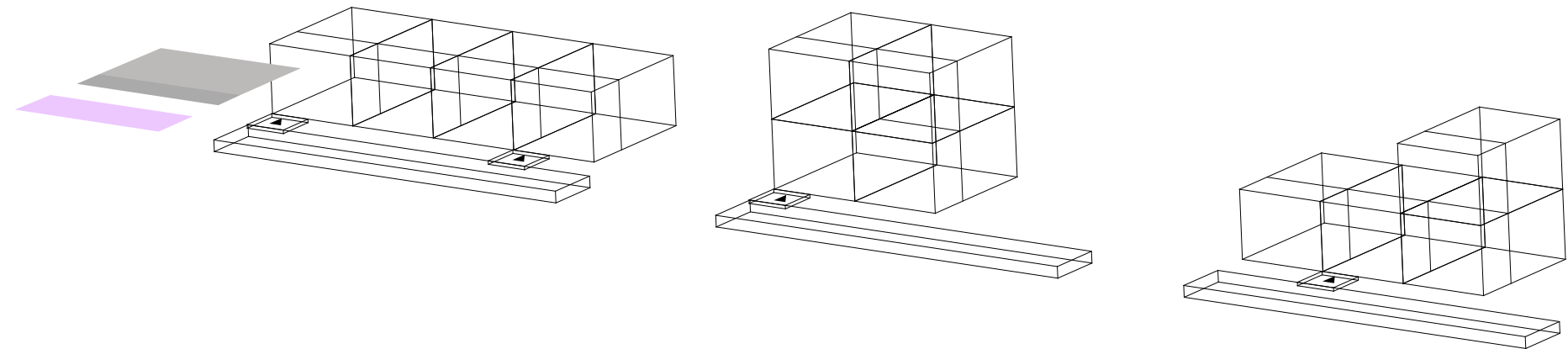

- wohnzone: wohn- und schlafbereich, mz variante, rückzugsbereiche, arbeitsberieche, gallerie + maisonette - variante
- versorgungszone: erschliessung, wc, bad sep. möglich
- kontaktzone: erschliessungsbrücke, vergrößerte freiflächen
- zielgruppe: eltern + jugendliche, erste abkapselung der kinder, sep. erschliessbar für untermieter, generationen wohnen paare mit heimbüro



